

**OPERATOR'S
UNIT, DIRECT SUPPORT AND GENERAL SUPPORT
MAINTENANCE MANUAL
FOR
LEAD-ACID STORAGE BATTERIES**

4HN, 24 VOLT (DRY) (NSN 6140-00-059-3528)	M11188/2-24v
4HN, 24 VOLT (WET) (NSN 6140-01-396-1968)	M11188/2-24v
2HN, 12 VOLT (DRY) (NSN 6140-00-057-2553)	MS35000-2
2HN, 12 VOLT (WET) (NSN 6140-01-390-1969)	MS35000-2
6TN, 12 VOLT (DRY) (NSN 6140-01-210-1064)	MS35000-1
6TL, 12 VOLT (DRY) (NSN 6140-00-057-2554)	MS35000-3
6TL, 12 VOLT (WET) (NSN 6140-01-051-4900)	MS83149-1
6TLFP, 12 VOLT (DRY) (NSN 6140-01-431-1172)	6TLFP
6TLFP, 12 VOLT (WET) (NSN 6140-01-441-1697)	6TLFP
6TMF, 12 VOLT (DRY) (NSN 6140-01-446-9498)	6TMF
6TMF, 12 VOLT (WET) (NSN 6140-01-446-9506)	6TMF
6TGEL, 12 VOLT (GEL) (NSN 6140-01-444-2545)	6TGEL
NBB248, 12 VOLT (GEL) (NSN 6140-12-190-9024)	NBB248
NBB248GTW, 12 VOLT (GEL) (NSN 6140-01-439-0616)	NGB248

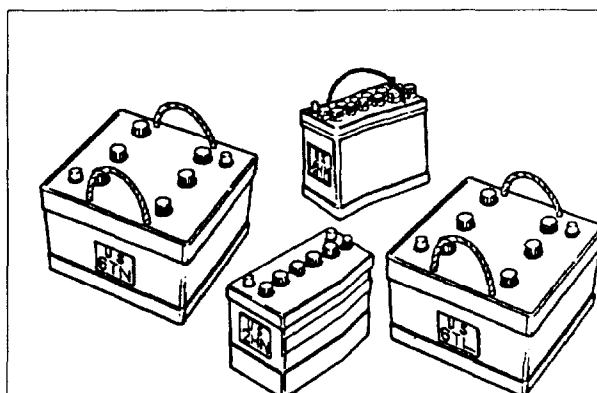

Approved for Public Release; Distribution is Unlimited

HEADQUARTERS, DEPARTMENT OF THE ARMY

11 September 1998

WARNING

LEAD-ACID BATTERIES CONTAIN SULFURIC ACID WHICH CAN CAUSE SEVERE BURNS.

Avoid contact with skin, eyes, or clothing. Wear safety goggles, face shield, and gloves.

If battery electrolyte is spilled, take immediate action to stop its corrosive (burning) effects:

- EXTERNAL: Flush with cold water to remove all acid.
- EYES: Flush with cold water for 15 minutes. Get medical attention at once.
- INTERNAL: Drink large amounts of water or milk. Follow with milk of magnesia, beaten egg, or vegetable oil. Get medical attention at once.
- CLOTHING OR VEHICLE: Wash at once with cold water. Neutralize with baking soda or household ammonia solution.

WARNING

Lead-acid battery gases can explode. Do not smoke, have open flames, other ignition sources, or make sparks around a battery, especially if the caps are off. If a battery is gassing, it can explode and cause injury to you.

WARNING

Nickel-cadmium batteries (vented or sealed) will not be permitted in a lead-acid battery shop. They will not be transported or stored with lead-acid batteries.

WARNING

Electrolyte and battery corrosion (Greenish/White) can cause injury to you. Wear safety goggles, face shield, and gloves. If for any reason electrolyte or battery corrosion (greenish/White) contacts the eyes, skin, or clothing, flush immediately with large amounts of cold water. In case of eye or skin contact, see a doctor immediately.

WARNING

Do not use metal or galvanized equipment when draining electrolyte from lead-acid batteries, electrolyte will damage equipment.

For the best performance do use the standard electrolyte used in the 6TL battery in the 6TLFP, use only the overpacked electrolyte.

WARNING

Do not use open and sealed lead-acid batteries together in one set of batteries. May cause an explosion and result in injury to personnel. Also, do not charge sealed and lead-acid batteries together.

Technical Manual
No, 9-6140-200-14*

HEADQUARTERS
DEPARTMENT OF THE ARMY
Washington, D.C., 11 September 1998

**OPERATOR'S, UNIT,
DIRECT SUPPORT AND GENERAL SUPPORT
MAINTENANCE MANUAL
FOR
LEAD-ACID STORAGE BATTERIES**

4HN, 24 VOLT (DRY) (NSN 6140-00-059-3528)	M11188/2-24v
4HN, 24 VOLT (WET) (NSN 6140-01-396-1968)	M11188/2-24v
2HN, 12 VOLT (DRY) (NSN 6140-00-057-2553)	MS35000-2
2HN, 12 VOLT (WET) (NSN 6140-01-390-1969)	MS35000-2
6TN, 12 VOLT (DRY) (NSN 6140-01-210-1064)	MS35000-1
6TL, 12 VOLT (DRY) (NSN 6140-00-057-2554)	MS35000-3
6TL, 12 VOLT (WET) (NSN 6140-01-051-4900)	MS83149-1
6TLFP, 12 VOLT (DRY) (NSN 6140-01-431-1172)	6TLFP
6TLFP, 12 VOLT (WET) (NSN 6140-01-441-1697)	6TLFP
6TMF, 12 VOLT (DRY) (NSN 6140-01-446-9498)	6TMF
6TMF, 12 VOLT (WET) (NSN 6140-01-446-9506)	6TMF
6TGEL, 12 VOLT (GEL) (NSN 6140-01-444-2545)	6TGEL
NBB248, 12 VOLT (GEL) (NSN 6140-12-190-9024)	NBB248
NBB248GTW, 12 VOLT (GEL) (NSN 6140-01-439-0616)	NGB248

REPORTING ERRORS AND RECOMMENDING IMPROVEMENTS

You can help improve this manual. If you find any mistakes or if you know of a way to improve the procedures, please let us know. Mail your letter, DA Form 2028 (Recommended Changes to Publications and Blank Forms), or DA Form 2028-2, located in the back of this manual, directly to: Commander, US. Army Tank-automotive and Armaments Command, ATTN: AMSTA-AC-NML, Rock Island, IL 61299-7630. A reply will be furnished directly to you. You may provide DA Form 2028-2 information to TACOM via datafax or e-mail.

e-mail address is amsta-ac-nml@ria-emh2.army.mil.
fax number is DSN 793-0726 or Commercial (309) 782-0726.

*This manual supersedes TM 9-6140-200-14, dated 13 July 1989.

Table of Contents

		PAGE
CHAPTER 1	INTRODUCTION	
Section I	General Information.....	1-1
Section II	Equipment Description and Data	1-1
Section III	Basic Battery Operating Principles	1-5
CHAPTER 2	OPERATOR/CREW MAINTENANCE INSTRUCTIONS	
Section I	General/PMCS Instructions.....	2-1
Section II	Maintenance Instructions.....	2--4
CHAPTER 3	UNIT MAINTENANCE	
Section I	General.....	3-1
Section II	Troubleshooting	3-4
Section III	Maintenance	3-4
CHAPTER 4	DIRECT SUPPORT AND GENERAL SUPPORT MAINTENANCE INSTRUCTIONS	
Section I	General.....	4--1
Section II	Maintenance Procedures	4--1
CHAPTER 5	SEALED LEAD-ACID BATTERIES (GEL)	5--1
CHAPTER 6	BATTERY DISPOSITION AND DISPOSAL	6--1

“Approved for public release; distribution is unlimited.”

APPENDIX B	MAINTENANCE ALLOCATION	
Section I	Introduction	B-1
Section II	Maintenance Allocation Chart (MAC)	B-6
Section III	Tool and Test Equipment	B-7
Section IV	Remarks	B-9
APPENDIX C	EXPENDABLE/DURABLE SUPPLIES AND MATERIALS LIST	
Section I	Introduction	C-1
Section II	Expendable/Durable Supply and Materials List	C-2
APPENDIX D	GUIDANCE FOR LOCAL BATTERY SHOP SOP	D-1
APPENDIX E	PROCEDURES FOR DRAINING VENTED LEAD-ACID BATTERIES AND DISPOSITION OF DRAINED SULFURIC ACID (ELECTROLYTE)	E-1
APPENDIX F	DISPOSAL REQUIREMENTS BY STATE	F-1
APPENDIX G	GLOSSARY	G-1

CHAPTER 1

INTRODUCTION

Section I. GENERAL INFORMATION

1-1 Scope.

This manual is for all levels of maintenance on lead-acid batteries. The lead-acid storage batteries covered in this manual are used in different types of military equipment.

1-2 Maintenance Forms and Records.

Required Maintenance forms and records are listed and explained in DA PAM 738-750, The Army Maintenance Management System (TAMMS).

1-3 Reporting Equipment Improvement Recommendations (EIR).

If your equipment needs improvement, let us know. Send us an EIR. You, the user, are the only one who can tell us what you don't like about your equipment. Let us know why you do not like the design. Tell us why a procedure is hard to perform. Put your improvement on an SF 368 (Quality Deficiency Report). Mail SF 368 to us at: Commander, U.S. Army Tank-automotive and Armaments Command, ATTN: AMSTA-TR-E/MPA, Warren, MI 48397-5000. A reply will be furnished to you.

Section II EQUIPMENT DESCRIPTION AND DATA

1-4 Purpose.

A storage battery is an electro-chemical device. It stores chemical energy which is released as electrical energy. When the battery is connected to an external load such as a starter, the chemical energy is converted into electrical energy and current flows through the circuit.

1-5 Capabilities and Features.

The lead-acid storage battery performs three (3) functions in automotive applications. These are:

TM 9-6140-200-14

- (a) Provides electrical energy in the form of large electrical currents to crank the engine.
- (b) Provides electrical current to operate electrical equipment for a reasonable period of time when the engine is not running, or when electrical system demands exceed that of the generator/alternator output.
- (c) Acts as stabilizer, maintaining voltage levels for electrical distribution circuits.

1-6 Location and Description of Major Components.

The location and description of the major components of the battery (See Figure 1-1) are listed below:

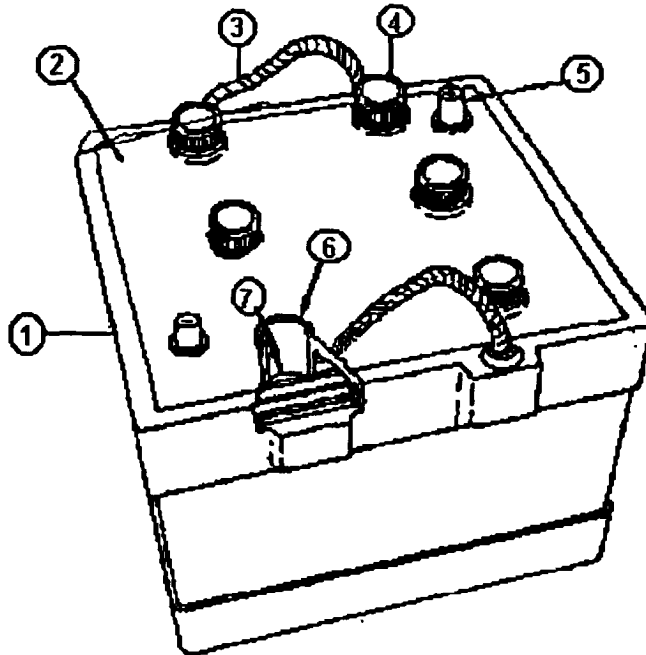

Figure 1-1

- a. Container (1). Made in one piece molded hard rubber or plastic, which is impervious to acid.
- b. Cover (2). Molded hard rubber or plastic, which provides an acid tight seal for top of container.
- c. Handle, Carrying, (3) Made of nylon rope which is impervious to acid or may be build into the battery case with different material.

- d. Vent filler caps (4). (4HN, 2HN, 6TN, 6TL, 6TLFP and 6TMF) Prevents loss of electrolyte from battery. Contains small pressure activated vent hole to permit escape of gas pressure.

CAUTION

6TGEL and NBB248 are gelled electrolyte batteries, These batteries should not be opened for any reason, because it will damage the battery.

- e. Terminal (5). SAE and DIN type tapered lead posts protruding through top of battery. Positive (+) terminal measures 11/16-inch dia. at top. Negative (-) terminal measures 5/8-inch dia. at top. Positive and negative clamps fit their respective terminals on all batteries. Corrugations on side of battery indicate location of positive terminal.
- f. Vent (6). Molded as part of cover. Provides an opening in the top of each battery cell for adding electrolyte or distilled water (except Gels).
- g. Electrolyte Level Mark (7). (4HN, 2HN, 6TMF, 6TN, 6TL, and 6TLFP). Electrolyte will be no higher than the lower edge of vent. Distilled water or electrolyte will not be added when fluid level is at or above this mark. If overfull remove liquid to proper level.
- h. Battery Level Indicator (6TMF) next to Positive Post). It identifies level of electrolyte and/or condition of charge (if green not shown notify unit maintenance) they will add distilled water to the proper level (Except Gel Batteries).

1-7 Performance Data.

Performance data for 4HN (24 Volt), 4HN, 6TN, 6TL, 6TLFP, 6TMF and NBB248 (12 Volts) type batteries operating under normal conditions is provided below.

TM 9-6140-200-14

Model	4HN	2HN	6TN	6TL	6TLFP	6TMF	NBB248
WEIGHT (UNFILLED)	29 Lbs	28 Lbs	52 Lbs	56 Lbs	56 Lbs	52 Lbs	N/A
NORMAL WEIGHT (Filled)	38 Lbs	37 Lbs	72 Lbs	74 Lbs	74 Lbs	74 Lbs	86 Lbs
NORMAL VOLTAGE	24 Volts	12 Volts	12 Volts	12 Volts	12 Volts	12 Volts	12 Volts
RATED CAPACITY AT 20 HR RATE	21 Amp hrs	45 Amp hrs	100 Amp hrs	120 Amp hrs	100 Amp hrs	120 Amp hrs	100 Amp hrs
DISCHARGE AT 20 HR RATE	1.05 Amp	2.25 Amp	5 Amp	6 Amp	6 Amp	6 Amp	5 Amp
CHARGING RATE (Max)	1.05 Amp	2.5 Amp	5 Amp	6 Amp	5 Amp	5 Amp	5 Amp
COLD CRANKING AMPERE	N/A	200	550	600	625	725	725

Section III. BASIC BATTERY OPERATING PRINCIPLES

1-8. Battery Operation.

Lead-acid storage batteries consist of a number of identical cells. These cells contain two different lead plates. These plates are immersed in electrolyte (a solution of sulfuric acid and water). As the battery cell receives electrical energy (charges) or delivers electrical energy (discharges), there is a change in the chemical composition of the battery plates and the strength of the electrolyte. The voltage developed depends on the types of electrode materials and the electrolyte used. It is approximately 2.1 volts per cell in a typical lead-acid battery. Electrical energy is produced by the chemical action between the electrode materials and the electrolyte. The chemical actions start and electrical energy current flows from the battery as soon as there is a circuit between the positive and negative terminals (whenever a load such as the headlamps is connected to the battery). The electrical current flows as electrons through the outside circuit, as it does inside the battery.

1-9. When the Battery Discharges.

a. When an external circuit is completed, such as turning on the ignition starting an engine or turning on equipment lights, the lead-acid battery begins to discharge. Discharge begins when the sulfuric acid in the electrolyte acts on lead peroxide in the positive plates and the lead in the negative plates to form a new compound called lead sulfate. The sulfations are supplied by the electrolyte, which becomes weaker in concentration as discharge continues.

The decreased strength of the electrolyte is in direct proportion to the amount of electricity taken from the battery cells. When the sulfate in the electrolyte is used up, the battery stops producing (electricity) and it discharges (See Figure 1-2).

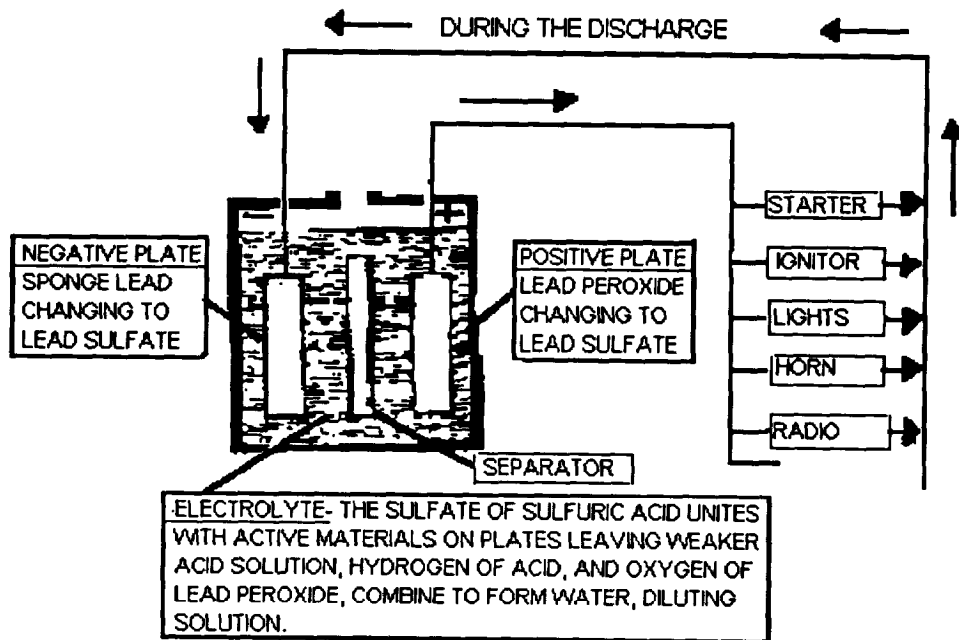

Figure 1-2

Described above has less of an effect on battery performance at lower discharge rates. At slow discharge rates practically all of the acid may be consumed, and the material near the centers of the plates has more of an opportunity to take part in the chemical reaction.

The lead-acid storage battery is chemically reversible. A discharged storage battery can be charged (pass electrical current through it in the direction opposite to the direction of discharge) and its active chemicals be restored to the charged state, ready to deliver its stored energy. This discharge, charge cycle can be repeated over and over until plate or separator deterioration or some other factor causes the battery to fail.

1-10 When the Battery Charges:

When an electrical current is passed through a lead-acid battery in a direction opposite of the discharge, the lead sulfate is decomposed or broken up. The sulfate is expelled or forced from positive or negative plates and returned to electrolyte. This restores the electrolyte to its original strength before the battery discharge. The lead in the negative plates and the lead peroxide in the positive plates are returned to the original condition. The battery is ready to deliver electrical energy again. (see Figure 1-3)

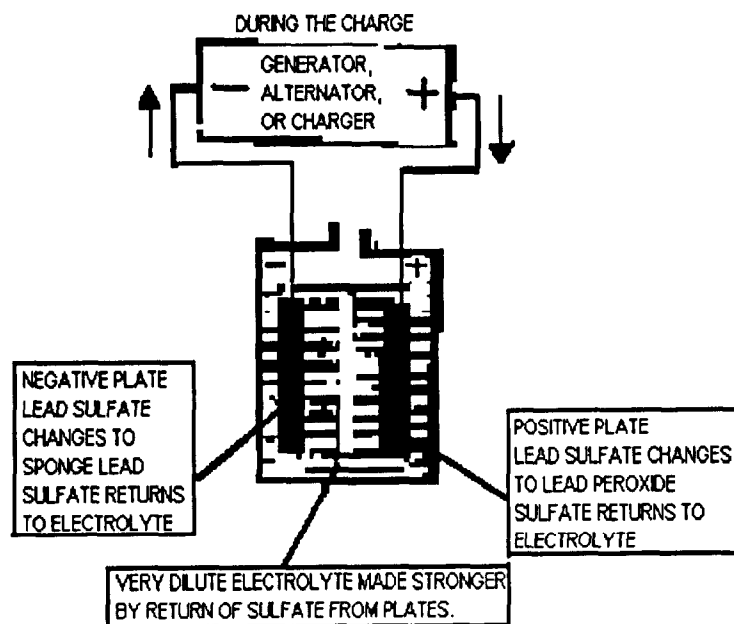
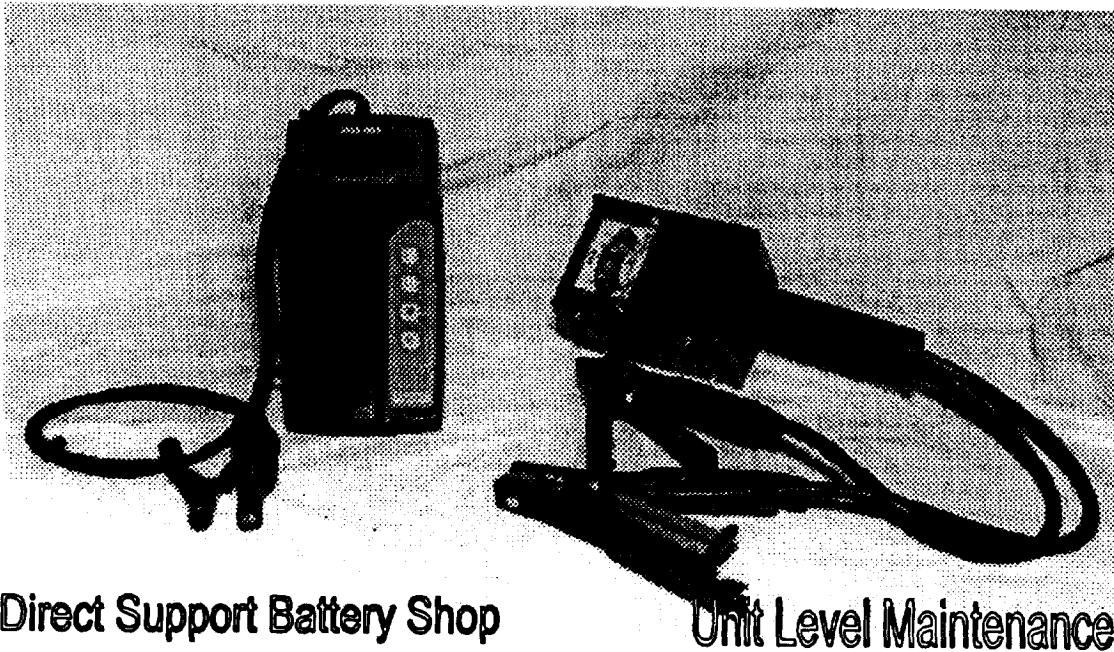

Figure 1-3

A battery can produce gas when it is being charged. Hydrogen is given off at the negative plate and oxygen at the positive. These gases result from the decomposition of water. When battery gasses it uses up water because it is being charged at a higher rate than it can accept. This may be due to the fact that the battery is fully charged, its plates are sulfated or it is too discharged to accept a charge. Generally, a battery will gas near the end of a charge because the charge rate is too high for the battery to accept it. Most automatic charger reduces the charge rate as the battery approaches the fully charged state eliminating most of this gassing. Causing them to gas means they are using water, which in sealed batteries, cannot be replaced. DO NOT overcharge these battery.

Note

There are different types of hand held battery testers available. Read tester instruction that are received with the equipment.



1. Unit Maintenance Hand Held Tester. The hand held battery tester assigned to unit level maintenance is a easy and quick way to check your battery (ies) for the following: (see chapter 3)
 - a. State of Charge: quickly indicates battery's open circuit voltage.
 - b. Battery load Test: The high current load simulates the vehicle's cranking load and evaluates the battery's ability to crank the vehicle.

2. Direct Support Battery Shop Hand Held Tester: The hand held battery tester assigned to battery shops at Direct Support or higher are used to determine the condition of the batteries before charging. This tester may be used to group batteries for charging as long as the battery has 5.5 volts or higher this tester will give you the Condition of the battery as follows: (see para 4-4 (d)).

CHARTER 2

Section I OPERATOR/CREW MAINTENANCE INSTRUCTION

2-1 General.

Refer to the applicable vehicle/equipment operator's manual for battery location.

2-2 Preventive Maintenance Checks and Services (PMCS).

See your Equipment/Operators Technical Manual for PMCS.

2-3 Defective Battery Characteristics.

The following are symptoms of a defective or poorly performing battery:

- a. Battery does not hold charge.
- b. Battery continuously shows low voltage on battery gauge.
- c. Vehicle generating system shows a high rate of charge for a long period well the equipment is operating.
- d. Excessive loss of electrolyte in any or all battery cell (s).
- e. Battery case leaking electrolyte.
- f. Battery case is swollen or buckled. (All except GEL type batteries)

2-4 Operation Under Usual Conditions.

- a. Keep your vehicle batteries at full charge. Automotive batteries are designed with the expectation that equipment use will keep the batteries fully charged at all times. Allowing the battery to discharge below 10.5 volts not only prevents it from starting your equipment, but also causes damage that shortens battery life. The more often you allow your batteries to go dead, the more likely it is they will fail completely. In addition, sulfate from the acid becomes very difficult to remove when left on the battery plates for months at a time, which decreases the capacity of the battery. If your batteries are brought to full charge on a regular basis, they will lose the ability to take a full charge and will fail prematurely.
- (1) Run the engine often enough to keep the battery charged. All batteries slowly lose charge while the equipment is not running. Under normal conditions, your equipment should be operated at least once every three months to keep the battery near full charge. More often is better, for both the battery and the equipment. Failure to recharge the battery periodically during long-term equipment storage will result in a battery that is dead and damaged.
 - (2) Run the engine fast enough to charge the battery. At low idle, engine electrical system will not generate enough voltage to charge the battery. The typical engine must be run at speeds of 1000 to 1200 RPM to generate enough voltage. This is equivalent to high idle, or a vehicle speed of 20 miles per hour or faster. Your equipment may be different, so check your equipment manual to make sure these parameters are correct. Use of lights, radios, or other accessories while idling the engine at low RPM will discharge your battery; just the same as using them with the engine off.
 - (3) Run the engine long enough to bring the battery back to full charge. A battery typically requires 20 to 30 minutes of charging to replace the power used to start the engine. Numerous short periods of operation (less than 20 minutes at a time) will eventually discharge the battery, even if the engine is operated at high speed. Extended operation at high idle is hard on most engines. Refer to your equipment manual and local SOP before running your equipment at high idle for extended periods.

TM 9-6140-200-14

- b. Do not overcharge your batteries. The higher the engine RPMs, the more voltage the generator produces. Your equipment has a voltage regulator, which prevents the voltage from rising above set level. Its primary purpose is to keep the generator from overcharging the battery. A higher voltage will not make the equipment run better. If the voltage regulator is set too high, the battery will be overcharged, resulting in excessive water consumption. Conventional batteries will require filling more frequently, and maintenance free batteries will fail prematurely. If the voltage regulator is set too low, the battery cannot be fully charged. Check your equipment TM for proper voltage adjustment. If your equipment ammeter indicates the voltage regulator is not set within specifications, notify unit maintenance to have it adjusted properly.

2-5 Operation Under Unusual Conditions.

- a. Hot Weather Operation. Check battery condition more often in hot climates (where the temperature rarely drops below freezing). High temperatures increase both battery water consumption and battery self-discharge.
 - (1) Batteries in equipment undergoing long term storage in hot climates should be checked and recharged at least once every 60 days (two months).
 - (2) Proper voltage regulator setting is especially important in hot climate.
- b. Cold Weather Operation. Battery water consumption and self-discharge are both greatly reduced at temperature below freezing. Unfortunately, battery performance drops off sharply with temperature as well. At the time, cold temperatures thicken lubricants, making the engine harder to crank. Also, discharged batteries can freeze at 10 degrees F.
 - (1) Check your equipment TM and operator's manual for cold weather starting instructions.
 - (2) If your equipment has a winterizing kit that includes a battery heater, use it.
 - (3) Use proper cold-weather lubricants and fuels to insure quicker, easier engine starting.
 - (4) Make sure the battery is warm before checking battery level indicator.

- (5) Keep your battery fully charged. A fully charged battery can withstand temperatures of -70 degrees F without freezing. A discharged battery can freeze at 10 degrees F.
- (6) When equipment with conventional batteries will not start at low temperatures, turn off all starting switches and check for a frozen battery before attempting to slave start or boost charge. Take off all filler caps and visually examine the electrolyte (do not attempt this procedure will GEL batteries, as their filler caps are not removable). If the battery case is buckled, swollen, or cracked or if you can see ice or frost inside any cell, notify unit maintenance that the battery is frozen. If no indication of ice present, replace all filler caps before proceeding.

CAUTION

Do not attempt to operate equipment with frozen batteries.
Do not attempt to slave start equipment with a frozen battery.
Do not attempt to charge a frozen battery. Attempting any of
These actions may cause the battery to explode.

Section II MAINTENANCE INSTRUCTIONS

2-6 General.

This section contains troubleshooting and maintenance information for the equipment operator/crew.

2-7 Troubleshooting.

Operator/crew troubleshooting consists of monitoring all equipment battery condition indicators (voltmeters or ammeters) for readings which might indicate battery problems (too high or too low readings). After engine starts, and if battery indicators are abnormal and do not return to the normal operating range within thirty (30) minutes of engine running time, notify unit maintenance.

2-8 Maintenance.

Operator/crew maintenance is covered under Section I, Paragraph 2-2.

CHAPTER 3

UNIT MAINTENANCE

Section I. GENERAL

3-1 Battery Maintenance.

Authorized Maintenance

- (1) Unit maintenance is authorized to charge batteries on equipment assigned to the unit. Charge batteries only in authorized open areas using authorized, assigned equipment.

NOTE

Do not stock electrolyte (a solution of sulfuric acid) at the unit maintenance level during peace time operations. Batteries needing repair or service for replacement will be forwarded to Direct Support Maintenance for service or other disposition. During wartime operations, battery and battery related equipment, Source, Maintenance, and Recoverability (SMR) Codes will be changed to recognize the immediate decentralization of authority to unit level for requisitioning. Included in this change will be the authority to activate, test and charge batteries using authorized unit Table of Equipment (TOE).

- (2) Unit maintenance is authorized to maintain batteries in accordance with established local maintenance procedures and this TM.

Activation of Assets.

- (3) New or serviced batteries received from direct exchange unit will be stocked and maintained in accordance with approved local unit maintenance procedures and unit TOE.
- (4) Organization Maintenance Shops (OMS) of the Army National Guard Units and Area Maintenance Support Activity (AMSA) will obtain authorization from the respective Major Commands (MACOMs) to activate, test and charge batteries. These request will be made only when battery service facilities meeting OSHA, EPA Standards and State Regulations are to be used.

3-2 Preventive Maintenance Checks and Services (PMCS)

WARNING

- To avoid eye injury, wear eye protection when working around batteries. The gasses produced by a Lead-Acid battery can explode. Do not smoke, have open flames, or make a spark if filler caps are off.
- Remove all jewelry, such as rings, ID tags, watches, and bracelets. If jewelry contacts a battery terminal, a direct short will result in instant heating may cause injury to personnel and/or damage equipment.

CAUTION

To reduce battery damage, do not remove batteries from equipment/battery compartment except during scheduled maintenance or during battery replacement. Do not wiggle or jerk battery cables during inspection. Battery replacement will be performed by unit maintenance personnel.

Interval	Item to be check/service	Operator/Crew Procedure	Not Fully Mission Capable if:
Semi-Annually	Vehicle/Equipment Batteries	<ul style="list-style-type: none"> a. Remove storage batteries from Vehicle (refer to Vehicle TM). b. Check electrolyte level. If Low add distilled water. c. Check and record specific gravity of each cell in all batteries. You may use the hand held tester to do this test. d. Clean battery Compartment 	<ul style="list-style-type: none"> b. Electrolyte is not at proper level. c. Specific gravity is not within standards. Battery test not within limits.

Interval	Item to be Check/service	Operator/Crew Procedure	Not Fully Mission Capable if:
Semi-Annually	Vehicle/Equipment Batteries	<ul style="list-style-type: none"> e. Check for damaged terminal posts. f. Install batteries (refer to vehicle TM) g. Check battery cables, splits, breaks and tightness. h. Coat battery terminals lightly with grease or silicone. 	<ul style="list-style-type: none"> e. Terminals or posts damaged. f. One or more battery missing or unserviceable. g. cables missing, frayed, broken or loose.

3-3 General servicing Instructions.

- a. If distilled water is added, let battery stand for about one hour before checking the specific gravity for each cell.
- b. Make sure filler caps are clean and present, do not paint or apply any material to them (Batteries with vent caps only) (Do not remove filler caps/plugs from GEL batteries).
- c. Place rubber grommets on to keep cables from being cut on edge of holes where the cables goes through the frame of vehicles.
- d. Use the hand held tester to check condition of battery or check electrolyte with the optical tester.

Section II. TROUBLESHOOTING

3-4 Troubleshooting.

Refer to the appropriate equipment manual for specific battery troubleshooting procedures. General troubleshooting of batteries/generators/alternator system includes the following:

SYMPTOM	PROBABLE CAUSE
No current from battery	Corroded/loose cable connection.
Battery does not stay charged.	Battery/generator indicator inoperative.

Section III. MAINTENANCE

3-5 General Storage of Batteries.

Do not stack batteries on top of each other. Battery weight will push the positive and negative posts into the battery casing. This can damage the battery plates. If batteries are stacked, battery weight on the caps can crack or break caps or top of the battery.

Store single batteries on a platform or on boards. Elevate batteries sufficiently above floor or ground level to keep them from dirty surfaces or water.

If necessary, fabricate a sturdy battery storage rack using 3/4 x 10 x 12 inch lumber uprights and 2 x 4 x 38 inch lumber for shelves. Fasten (nail) the wood members securely together and cross-brace members corner-to-corner.

3-6 Storing Batteries Before Charging.

- a. Store in a cool place to minimize battery self-discharge. The hotter the storage area, the faster batteries will self discharge,
- b. Do not use the battery shop as a storage area for batteries, only store dry charged batteries as Prescribed Load List (PLL) items.
- c. Do not remove electrolyte from batteries during storage.

3-7 Testing Batteries With a 12 volt Battery Load Tester.

NOTE

Do Not Test 24 volt system with this tester
It will damage the tester. Its a good idea to
Charge the battery after this test.

1. This test evaluates the battery's ability to crank an engine. The tester draws current from the battery while measuring its voltage level. the voltage level of a good battery will remain relatively steady under load, but a defective battery will show a rapid loss in voltage. Battery size (CCA rating) and temperature will affect test results- follow instructions carefully.
 - a. Turn off engine, accessories and battery test equipment.
 - b. Disconnect all vehicle battery cables/clamps.
 - c. Connect negative (black) clamp to the negative (-) battery post. Connect the positive (red) clamp to the positive (+) battery post. Make sure a good electrical connection between post and clamp.
 - d. With the clamps connected, tester's meter will indicate battery's STATE OF CHARGE. Recharge battery if state of charge is less than 12.5 volts before load testing. If charging does not bring voltage to 12.5 battery is defective. If meter needle is off scale to the left, check for loose or reversed clamps, other wise battery is defective.
 - e. Note battery reading's rates in cold cranking amperes (CCA). If rating is not printed on the battery use the following guideline to estimate battery size. 2HN, 220 CCA; 6TL, 600 CCA; 6TLFP, 625 CCA; and 6TMF, 725 CCA.
 - f. Depress load switch for ten (10) seconds.
 - g. Read meter at the end of ten (10) seconds-with switch depressed.
Refer to load test analysis chart following:

METER ACTION AT END OF 10 SECONDS	BATTERY CONDITION INDICATED
Needle in Temperature corrected Green Scale	Battery is Good
Little if any movement , needle in temperature corrected yellow scale	Battery Questionable Recharge and Retest
Noticeable Meter Movement and /or needle in temperature corrected Red scale	Battery Defective Replace.

COMPENSATING FOR LOW TEMPERATURES:

Low temperature has a degrading effect on batteries and will affect test results. This can be compensated by reading a different scale.

If battery is 50 degrees F, read scale 100 CCA less than battery rating.

If battery is 30 degrees F, read scale 200 CCA less than battery rating.

If battery is 0 degrees F, read scale 300 CCA less than battery rating.

Also, follow instruction that is over packed with the Battery Tester.

3-8. Measuring Specific Gravity with Battery Tester.

- a. Optical Battery Tester (Figure 3-1). This tester is quick, it uses no mathematics, and automatically compensates for temperature. The following procedures describes the use of the optical tester: Do not use this tester on GEL type batteries.

WARNING

To prevent injury to personnel or damage to equipment, be careful do not to splash electrolyte during battery testing.

- (1) Test the battery before adding water.

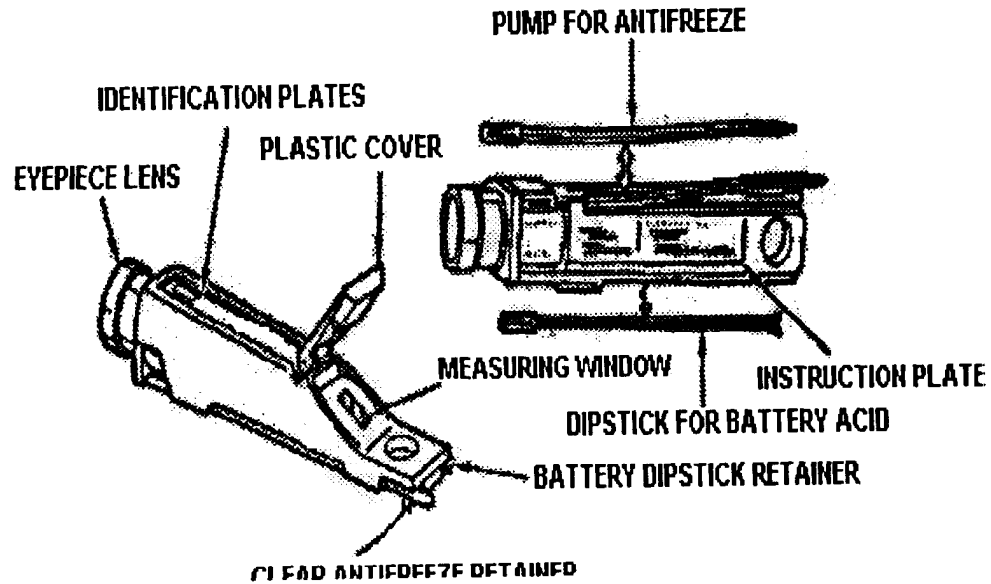

Figure 3-1

NOTE

Keep the plastic cover against the measuring window when testing. A faulty reading could be obtained if the electrolyte sample begins to evaporate.

- (2) Clean the plastic cover and measuring window of the tester. Wipe with a clean soft cloth. Thoroughly clean the eyepiece lens with water.
- (3) Swing the plastic cover down until it rests against the measuring window.
- (4) Perform a separate test for each battery cell.

- (5) Using the black dipstick, place a few drops of electrolyte on the exposed portion of the measuring window (Figure 3-2).

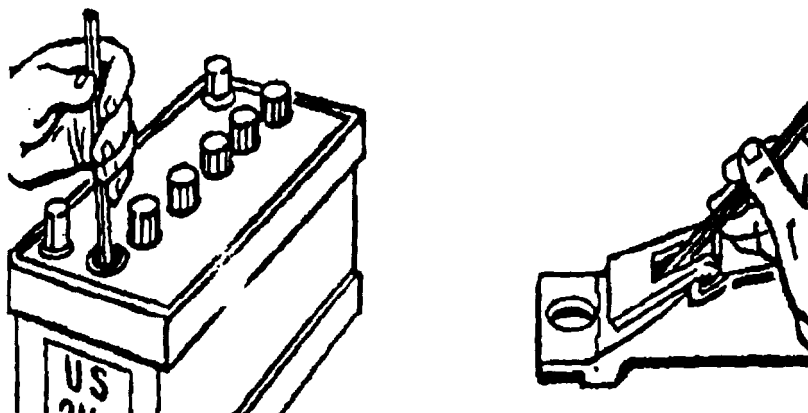

Figure 3-2

- (6) Point the tester toward a bright light source. Look into the eyepiece and locate the rectangle with two calibrated scales. Battery charge readings are taken from the left scale.

NOTE

If the line where the light and dark areas meet is not sharp and clear, the plastic cover and measuring window have not been properly cleaned and dried. Thoroughly wash and dry the tester until a sharp clear image is obtained. Repeat test.

- (7) The electrolyte sample will divide the rectangle into an area of light and an area of shadow. Read the scale (Figure 3-3) where the light and shadow meet. The acceptable full charge and minimum charge specific gravity limits shall be as follows:

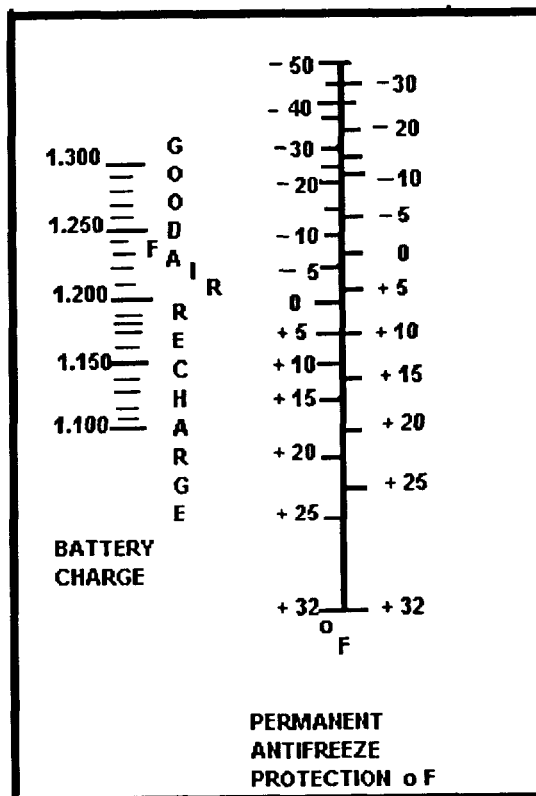

Figure 3-3

TM 9-6140-200-14

b. Optical Tester Maintenance.

- (1) After each use, clean and dry all tester parts.
- (2) Keep the plastic cover and measuring window of the tester thoroughly cleaned and dried. This will insure a clear view of the tester scale and rectangle during battery testing.
- (3) Optical Tester Accuracy check.

Here's how to test the tester.

- a. Take a reading using distilled water (Item 6, Appx C).
- b. If reading is more than 34 degrees F or less than 30 degrees F, your tester needs adjusting. Take three (3) or four (4) readings to be sure.
- c. If a reading is off, remove the instruction plate on the bottom by working a knife under the edge.
- d. Carefully dig out the sealer over the screws closest to each end.
- e. The screw farthest from the eyepiece controls the 32 degree Fahrenheit end of the scale. Use a small screwdriver to adjust the screw. Clockwise increase the reading; counterclockwise reduces it. Make sure the final adjustment to 32 degrees Fahrenheit is clockwise (See Figure 3-4).
- f. Now check the minus side of the scale. Mix up a solution of exactly one part distilled water and one part anti-freeze. (stir well). Take several readings with the anti-freeze solution. If reading is more than - 32 degrees Fahrenheit or less than -36 degrees, adjust to -34 degrees Fahrenheit.

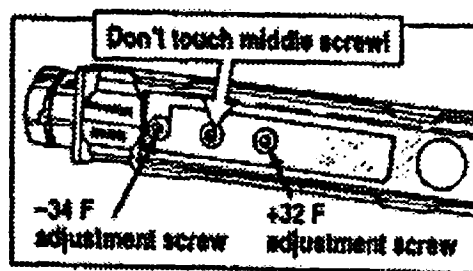

Figure 3-4

- g. Using the screw closest to the eyepiece. Again, make sure the last adjustment to -34 degrees is clockwise.
 - h. Rinse the tester and recheck with distilled water.
 - l. Repeat the adjustment for 32 degrees if necessary. Then recheck using the anti-freeze solution.
 - j. When both settings check out use a little adhesive (Item 1, Appx. C) to hold screws in place.
 - k. Replace the instruction plate.
- (4) Check the area around the tester window. If there is a separation between the tester window and tester body, battery acid has deteriorated the cement (glue) and could cause the tester to give a defective reading. Replace tester.
- (5) Clean and dry tester after each use.

c. **Bulb-Type (Hydrometer) Tester.**

1. If the optical tester is not available, the bulb-type hydrometer tester may be used. This tester uses a hydrometer (float) to test the battery electrolyte.
2. The specific gravity of the electrolyte solution is read directly from the float scale, which is marked to read in units of specific gravity. A direct reading from the float scale is correct only at 80 degrees Fahrenheit. When the temperature of the battery solution is above or below 80 degrees, the float reading must be corrected to obtain an accurate electrolyte specific gravity reading. The tester is fitted with a thermometer, which reads in degrees Fahrenheit. The thermometer is used to indicate the temperature of the battery electrolyte solution. The following procedures describe the use of the bulb-type tester:

WARNING

To prevent personnel injury or damage to equipment, be careful not to drip electrolyte during battery testing or while reading hydrometer.

TM 9-6140-200-14

- (a) Remove one of the battery filler caps and check the liquid level of the battery cell.

NOTE

To get an accurate reading, the liquid of the battery cell should be at normal height when the battery is tested. Any water added to the battery should thoroughly mixed with the electrolyte by charging the battery before testing. If the battery is dry, and a field charge is not permitted, Replace defective battery.

- (b) If allowed, add water to battery and bring to normal level.
- (c) Charge battery to mix water with existing electrolyte.
- (d) Insert tip of tester into cell and draw enough electrolyte to float the glass hydrometer in the barrel of the tester.
- (e) Take electrolyte specific gravity reading.
- (f) Check tester thermometer. If thermometer indicates battery solution is 80 degrees Fahrenheit., take specific gravity reading directly from the hydrometer scale. If thermometer indicates battery solution temperature is above or below 80 degrees, perform electrolyte temperature check (paragraph d (2). which follows:
- (g) Record reading.
- (h) Return electrolyte to battery cell and install battery cap.
- (i) Make a separate test for all other battery cells and record readings. Install all battery filler caps.
- (j) Check each cell of the battery, it must be within 0.025 maximum specific gravity of all other cells. If a greater difference exists between any two cells, battery is defective. Replace battery.
- (k) After using tester, flush hydrometer with clean, clear water.

3. Electrolyte Temperature Correction. When the temperature of the battery electrolyte is above or below 80 degree F, the reading taken from the hydrometer must be adjusted to get a correct battery cell specific gravity, correct for temperature as follows:

(a) Perform steps in para 3-8c (2)a thru e.

(b) Check tester thermometer. If thermometer reads above or below 80 degree Fahrenheit adjust electrolyte specific gravity reading as follows:

(1) For every 10 degrees Fahrenheit below 80 degrees Fahrenheit, subtract four (4) specific gravity units from electrolyte reading taken.

(2) For every 10 degrees above 80 degrees Fahrenheit, add four (4) specific gravity units from electrolyte reading taken (see examples below).

EXAMPLE 1

Battery electrolyte temperature reading is 60 degrees Fahrenheit and the hydrometer shows a specific gravity of 1.240. Since 60 degrees is two 10's below 80 degrees Fahrenheit, you must subtract two 4's or eight (8) specific gravity units from hydrometer reading. This leaves a corrected specific gravity reading of 1.232 (See Figure 3-6).

EXAMPLE 2

Battery electrolyte temperature is down to 20 degrees Fahrenheit and the hydrometer shows a specific gravity of 1.256. Subtract 20 from 80 to get 6 10's difference and 6 4's (24) subtract from 1.256 gives a corrected specific gravity of 1.232. (See Figure 3-6).

TM 9-6140-200-14

EXAMPLE 3

Battery electrolyte temperature reading is 100 degrees and the hydrometer specific gravity reading is only 1.224. The electrolyte temperature is two (2) 10's above 80 degrees Fahrenheit. You must add two 4's or eight specific gravity units to the original float reading to get a corrected specific gravity reading of 1.232 (See Figure 3-6).

(3) Perform steps in para. 3-8c (2)f thru k.

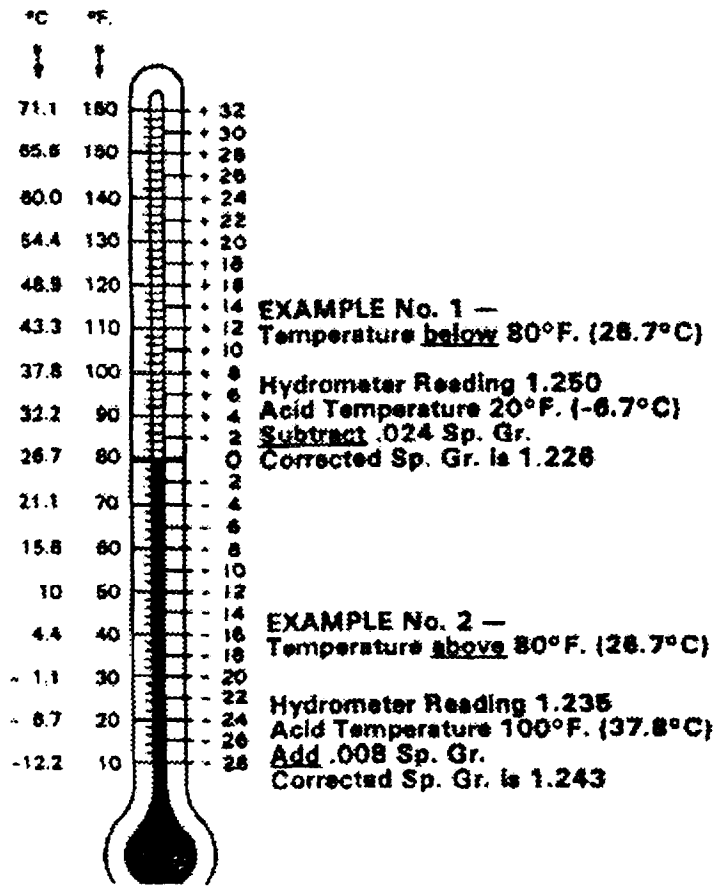

Figure 3-6

3-9. Water for Use in Batteries.

NOTE

Do not add distilled water to GEL type batteries

Use distilled water (Item 6, Appx. C) in lead-acid batteries. In emergencies a good grade of drinking water (excluding mineral waters) may be used. Adding water to a battery cell will lower the specific gravity of the electrolyte, but does not mean that the cell has lost any charge. Watch for batteries that require excessive water. When batteries require excessive water, this may be an indication of a charging system out of adjustment and may also indicate that the battery has been undergoing the damaging effects of overcharging.

3-10 Reverse Polarity in Lead-Acid Batteries.

If reverse polarity occurs in an equipment electrical system or during battery charging, the lead plates of the battery can be damaged. Turn battery in IAW your Local SOP.

3-11 Replacing Batteries.

WARNING

Batteries can explode. Do not smoke, have open flames or make sparks around batteries. If battery is gassing, it can explode and cause injury to personnel.

CAUTION

When removing a battery from a vehicle, note the location of the positive (+) battery terminal. This will allow the replacement battery to be installed in the same location and avoid the danger of reversing polarity of the circuit. Install battery lead identification labels (Figure 3-7) if they are missing. If you hook up a battery in reverse polarity, you will damage the vehicle electrical system and radios.

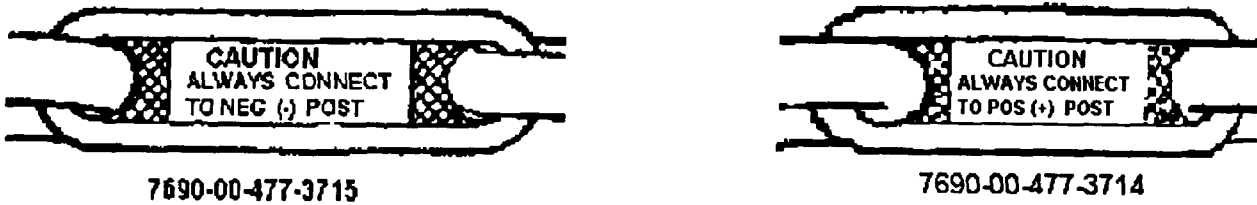

Figure 3-7

a. Battery Removal.

- (1) Take off the negative (-) battery terminal clamp first. Remove the hexagonal nuts on the end of the clamp (See Figure 3-8).

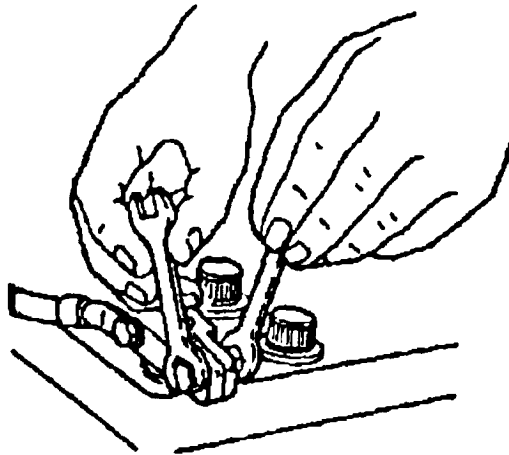

Figure 3-8

- (2) Remove negative (-) terminal clamp from terminal post using terminal puller (See Figure 3-9), install battery cable lead identification label at this time if label is missing.

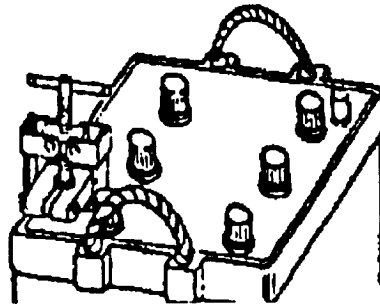

Figure 3-9

- (3) Remove positive (+) terminal clamp from terminal post using terminal clamp puller, install battery lead identification label at this time if label is missing.

NOTE

Most batteries require two-man lift

- (4) Remove Battery.
 - (a) Lift small batteries (2HN and 4HN with a carrying strap (Item 18, Appx B).
 - (b) Lift large batteries (4 HN, 6TL, 6TLFP, 6TMF and NBB 248) by carrying handles which are built into the battery casing or cover (See Figure 3-10).

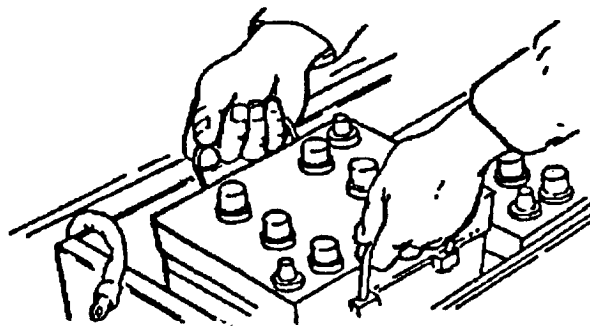

Figure 3-10

CAUTION

When removing and carrying batteries, be careful not to hit the battery against the sides of the vehicle or other structures. The battery casing can be cracked if struck by or against other objects.

- (c) Set battery down carefully on a board or wooden platform.

- b. **Corrosion Inspection.** Aside from a careful, general inspection of the condition of the battery, battery cables, battery box, hold down supports, and fasteners, a through inspection of the battery cables, terminal and fasteners should be made to detect the presence of corrosion.
 - (1) Effects of corrosion. As acid eats away terminals, terminal posts and exposed cable, corrosion builds up on these surfaces. This corrosion creates a resistance to current flow and restricts proper flow of current to the starter and the equipment electrical circuit. On equipment having voltage regulators, resistance caused by corrosion prevents the battery from receiving a sufficient charging current. After repeated battery use, this results in an undercharged, sulfated battery.

 - (2) Battery System Inspection. Inspect battery system for corrosion as follows:
 - (a) Inspect cable ends for corrosion and general condition. Check for worm insulation, breaks and buckling. Replace all unserviceable cables. Clean as required.

 - (b) Inspect battery terminal posts for corrosion and overall general condition. Clean as Required. After cleaning, check that cleaned cable terminals fit properly on the cleaned battery posts.

 - (c) Inspect battery, battery box, hold downs, clamps, supports, fasteners, adjacent equipment, etc. for corrosion and general serviceable condition. Clean, repair and/or replace as required.

c. **Cleaning:****WARNING**

Electrolyte and battery corrosion can cause injury to you. To prevent personal injury, wear safety goggles and gloves when handling batteries or battery solutions. If for any reason electrolyte or battery corrosion contacts the eyes, skin or clothing, flush these areas immediately with large amounts of water. In case of eye or skin contact, see a doctor immediately.

- (1) Use a wire brush (Item 1, Appx. B) and clean the corrosion, cracked paint and dirt from the battery hold-downs. (see Figure 3-11).

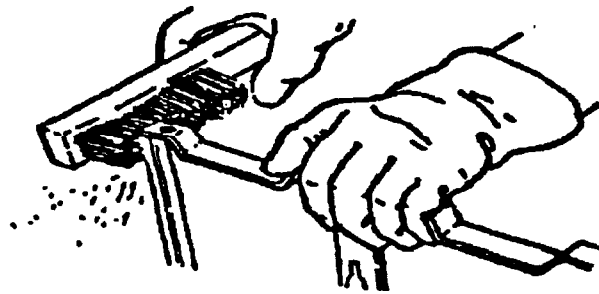

Figure 3-11

- (2) Soak the cleaned battery hold downs in a tub of water mixed with 2 pound of baking soda (Item 14, Appx. C) to each gallon of water. Rinse hold downs thoroughly. Apply epoxy coating, (Item 3, Appx. C) to hold downs. If that coating is not available, use bituminous coating (Item 4, Appx. C).
- (3) Thoroughly wash the battery tray or battery box and other nearby metal parts that are corroded, using a water baking soda solution (See Figure 3-12). Thoroughly rinse and dry these parts. Apply a 1/32 to 1/8 inch thick epoxy coating (Item 3, Appx. C) to these parts using one of the coating compounds above.

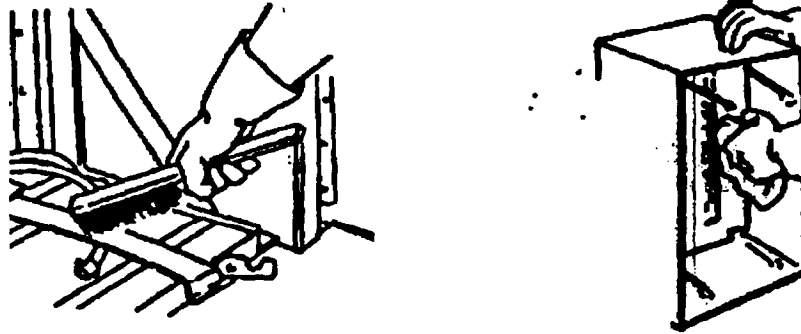

Figure 3-12

- (4) Carefully clean all battery clamps and terminals. Use terminal cleaning tool (Item 3, Appx. B).

CAUTION

Special care should be taken while cleaning corrosion from clamps and terminals to prevent excessive damage or abrasion to the surfaces which will affect their fit during installation.

- (5) During cleaning, inspect terminals and clamps and replace any damaged parts to the point that they no longer fit on the battery posts or if their ends touch when the clamp nut is tightened.

d. Battery Installation.

CAUTION

To prevent damage to equipment, make sure that the equipment master switch, radio and other electrical loads are turned off or disconnected during battery maintenance or replacement.

NOTE

When replacing individual batteries, make sure replacement batteries are at least the same electrical capacity as the old battery or as the battery pairs remaining in the equipment. Do not use any battery showing average difference of more than 0.025 specific gravity or 0.5 volt between other batteries used in the equipment. Charge batteries that do not meet the minimum requirement.

- (1) Check that new battery is fully charged and that battery capacity equals other batteries used in the equipment (Refer to Note above).
- (2) Install battery (ies) make sure they are clean and free of dirt, grease, corrosion, etc..

NOTE

Large batteries require two-man carry

- (3) Use carrying strap (Item 18, Appx. B) when handling small batteries. For large batteries use carrying handles build into the battery case or cover.
- (4) Install Battery
 - (a) Place battery in the battery tray or box carefully. Make sure battery is in a level position in the tray or box.
 - (b) Make sure positive battery cable is in same location as old battery cable when battery was removed.
 - (c) Fasten battery securely with battery hold downs.
 - (d) Tighten fasteners of the battery hold downs evenly a little at a time, first one side and then the other to prevent cracking of the battery case until the battery is securely seated. If one battery hold down is fixed type, make sure battery is securely seated before any pressure is applied to the moveable side. Do not over tighten hold downs.

CAUTION

To prevent damage to equipment, make sure that the positive (+) and negative (-) connections (polarity) of the battery are correct. Starting the engine with these battery connections reversed will damage the rectifier diodes and engine wiring harness beyond repair. On equipment with transistorized radios, damage to the radio may occur, if the radio is turned on with battery polarity reversed.

NOTE

In order to fit positive (+) battery post, the opening of the positive (+) cable is 1/16 inch larger than the opening of the negative (-) cable clamp.

- (e) Before connecting the battery cables, check position (+) and negative (-) connections of cables.
- (f) Install battery terminal lug cover (Appendix C, Item 5) on positive (+) battery terminal. (See Figure 3-13).

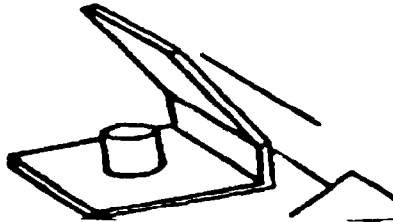

Figure 3-13

CAUTION

To prevent damage to battery or clamps, do not hammer cable clamps on battery posts. This can cause serious damage to battery cover or battery post connections inside the battery. Spread cable clamps if they are too tight to fit.

- (g) Prior to installing cable clamps, spread cable clamp (Item 14, Appx. B) as necessary to fit battery posts with battery clamp spreader (Figure 3-14).

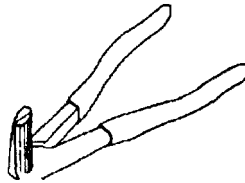

Figure 3-14

- (h) Install positive (+) battery cable first, Spread cable clamp as necessary to fit over positive battery post. Spread as required and install negative battery cable.
- (i) Tighten cable clamp nuts and bolts. Replace all clamps, bolts and nuts that will not tighten, worn or badly corroded.
- (j) Apply GAA or Silicone (RTV) (Item 10 or Item 15, Appx. C) to cable clamps after installing clamps on battery posts.
- (k) Tighten a little at a time while continuously checking the connection until it is secure (Figure 3-15).

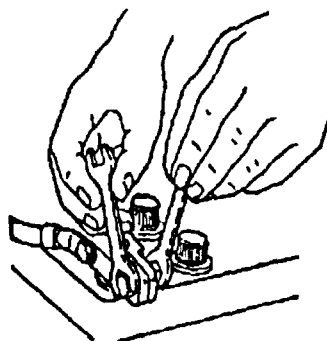

Figure 3-15

NOTE

To prevent damage to cable clamps, battery or battery posts, do not twist clamps with pliers to check tightness.

- (l) Tighten connection and check for tightness. Use the two finger method to check tightness.
- (m) Final check. Refer to the equipment -20 technical manual (unit maintenance) for procedures on battery installation and final check of cable connections. Pay particular attention to any procedures concerning the matching of the positive (+) cable to the positive post of the battery.
- (n) Vehicle/equipment fitted with ammeters. Turn on equipment lighting system and check that ammeter deflects to the minus (-) or discharge end of ammeter scale. If ammeter shows a discharge, hookup of batteries is correct for proper polarity. Apply a light coat of GAA or silicone (RTV) (Item 10 or Item 15, Appx. C) on clamps and terminals. Wipe off excess grease.
- (o) Make ground connection. Clean ground cable, ground cable mounting bolt and ground connection on equipment as required before making ground connection. Make sure area is free from dirt, paint and corrosion. Install mounting bolt and nut. Hold head of bolt with one wrench and tighten nut with the another wrench. Tighten nut little until connection is secure.
- (p) Complete battery installation. Check that rubber grommets are in place around cables to prevent cables from being cut or otherwise damaged in holes. Install battery terminal lug covers, (Item 5, Appx. C) over battery posts to prevent battery cover-to-terminal lug contact (See Figure 3-16).

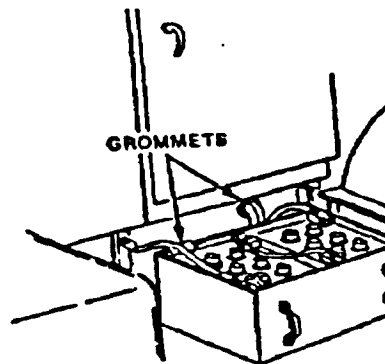

Figure 3-16

3-12. Transporting Batteries.

The following handling methods and precautions should be followed when transporting batteries:

CAUTION

Be careful not to drop batteries. Dropping batteries can crack the battery case or damage the inside of the battery.

- a. Transport batteries using battery carrier or use the battery handles built into the side of the battery casing.
- b. Do not drain electrolyte from batteries.
- c. Do not carry the battery loose in the bed of any truck or trailer.
- d. Follow OSHA, EPA, local and State Regulations.

3-13. Charging Batteries in the Field Using The 3KW Generator Set and Distribution Panel.

WARNING

- To prevent damage to equipment or injury to personnel, connect all cables properly. When all circuit breakers and power switches are in the off position. Start the generator and begin battery charging.
- Do not charge batteries in a confined area such as a building or closed tent.
- Do not charge batteries near any vehicles or areas containing flammable liquids or explosive materials that have a fifty (50) foot flame restriction.

NOTE

The 3kw generator and distribution panel operator must be licensed IAW TB 600-1 before any performing any charging operations.

TM 9-6140-200-14

a. Typical Equipment Setup using 3KW generator to charge a multiple group of batteries.

- (1) Set up charger in accordance with TM 5-6115-271-14. Set up distribution panel in accordance with TM 5-6130-301-13&P (Figure 3-18).



Figure 3-18

- (2) Keep the charging area clean.
- (3) Provide adequate ventilation and sufficient flow of cooling air around the generator engine.

- (4) Perform a complete PMCS on the generator and distribution panel using the appropriate equipment manual (Figure 3-19).

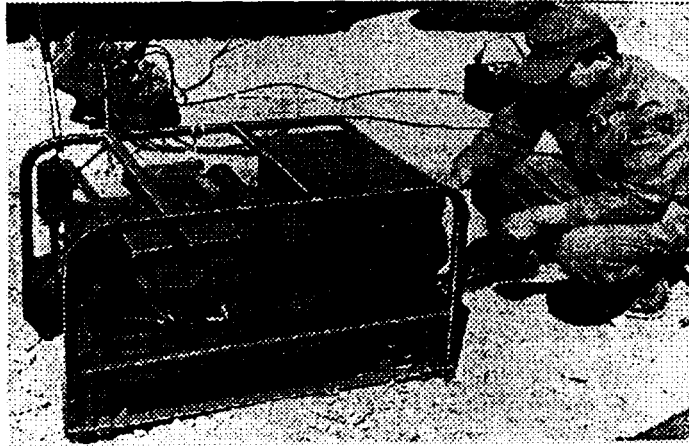

Figure 3-19

- (5) 12 Volt and 24 volt charging hookup operating at the same time (Figure 3-20).

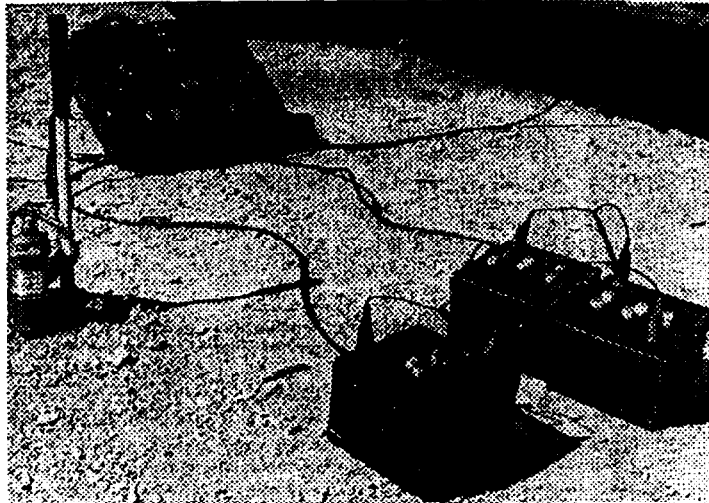

Figure 3-20

b. Prepare Battery For Charging.

- (1) Thoroughly clean the battery externally using a scrub brush and mixture of water and baking soda (Item 14, Appx. C).

NOTE

Do not add distilled water to GEL type batteries

- (2) Add distilled water (Appendix B, Item 6) to the battery to bring electrolyte to the proper level. Use gravity battery filler or syringe battery filler (Item 5 or 6, Appx. B).
- (3) Install the battery on the charger and check for battery amperage draw on the distribution panel. If the battery draws over 10 amperes, battery is defective. Turn battery in.
- (4) Check the battery for specific gravity. If specific gravity is below 1.100, the battery is defective. Turn battery in.

NOTE

If a new or recharged battery shows a difference of more than 0.025 specific gravity between cells, the battery is defective.

- (5) Group or match battery sets by specific gravity. Group batteries that are very close to 1.135 specific gravity and need little charging. If the batteries are charged in these groups of similar specific gravity, there is a better chance of the same charge for all batteries in the group.
- (6) Group batteries for charging by using the hand held battery tester and group batteries in accordance with the voltage. Group batteries as follows: Group 12.5 to 12.0, 11.5 to 12 volts, 11.0 to 11.5 volts, 10.5 to 11.0 volts and 10.0 to 10.5 volts.

3-14 Charging Batteries:

WARNING

- Lead-acid battery being charged produces a highly explosive hydrogen gas when being charged. Keep sparks, open flames and other ignition sources away from the charging area.
Do not smoke during battery charging operations.
 - If acid contacts the eyes, skin or clothing, flush immediately with large amounts of cold water. In case of eye or skin contact with acid, see a physician immediately.
 - Leave battery caps installed and slightly loosened when charging a battery. This will insure that the battery filler vents are open and will avoid pressure build up inside the battery and release battery gasses.
 - To prevent injury to personnel or damage to equipment, Connect all cables properly. Ensure all circuit breakers and power switches are in the off position before connecting battery cables to the battery.
- (1) Make sure battery charger is off.
 - (2) Connect positive (+) lead of the charger to the positive post of the battery.
 - (3) Connect negative (-) lead of the charger to the negative post of the battery.
 - (4) Turn charger on and begin charging the battery.
 - (5) Check battery voltage. Use the voltmeter section of the multi meter on the distribution panel to check battery voltage. Connect voltage leads to the 50 volt connections. Using these leads, touch the negative (-) and positive (+) posts of each battery under charge. A reading of approximately 14 volts should be shown at the terminal of each battery under charge. If one or more batteries shows less than 14 volts, perform the following checks.

TM 9-6140-200-14

- (6) Adjust charging amperage. Use the ammeter charging rate control knob to adjust ammeter amperage as near as possible to 5 amperes for each battery on charge (Figure 3-21).

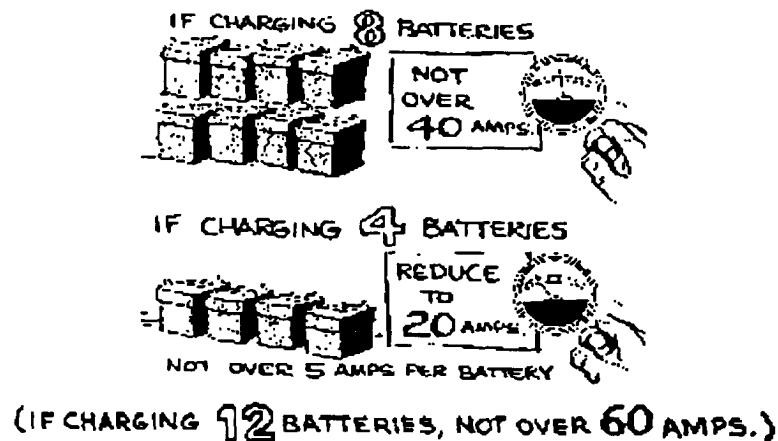

Figure 3-21

- (a) Check the cables on each battery showing low voltage. Check the location where the cable goes into the charger.
- (b) If any cable plug-in does not make connection to a receptacle, try interchanging cables at the charger. If this is not successful with any given cable connection, charger is defective. Turn in charger.
- (7) Use the following as a guide to recharge 12 volt lead-acid military batteries.
- a. Pretest Battery (ies).
- (1) Check all batteries for voltages and/or specific gravity readings. Use the hand held tester (Item 20, Appx. B) to check for voltage and Load testing and/or use the Optical (Item 21, Appx. B) or hydrometer (Item 19, Appx. B) for specific gravity readings.
 - (2) For open circuit voltage (OCV) you may also use a multi-meter (Item 12, Appx. B).
 - (3) Group batteries for charging as follows.

- b. Charging Procedures (6TLFP) by using charger assign at unit level.
 Read battery charger instructions overpacked with charger.

(1) Group batteries according to their OCV as follows for charging:

Voltage Readings	(Manufacturer Recommended) Approximate Charging hours (use as Guide Only)*
------------------	--

* Issued charger supplies at least 40 amps for each battery being charged.

(a) 10.5 to 11.0 voltage	18-20 hours
(b) 11.1 to 11.5 voltage	14-16 hours
(c) 11.6 to 12.0 voltage	10-12 hours
(d) 12.1 to 12.5 voltage	6-8 hours

(2) Use one of the following to measure Specific Gravity Optical battery tester NSN 6630-00-105-1418 or Hydrometer (Float) (80F/80F) NSN 6630-00-171-5126.

Hydrometer Tester Readings	Optical Tester Readings	Approximate Charging Hours
(a) 1.120 to 1.150	(a) 1.110 to 1.140	18-20 hours
(b) 1.151 to 1.180	(b) 1.141 to 1.170	14-16 hours
(c) 1.181 to 1.210	(c) 1.171 to 1.200	10-12 hours
(d) 1.211 to 1.245	(d) 1.201 to 1.235	6-8 hours
(e) 1.245 to 1.275	(e) 1.236 to 1.265	2-4 hours

NOTE

Any battery readings below 10.5 volts or 1.110 specific gravity readings may be slowly recharged, for at least 48 hours time permitting. if not recovered, turn in to your DRMO or servicing Contractor for recycling

- (3) Connect and Charge batteries IAW Battery Charger instructions provided.
- (4) After the batteries have been charged let them stand for at least 2 hours and then test the batteries.
- (5) Return batteries that pass the following requirements to service.
 - a. If you use your hand held Battery Tester according to the high discharge capacity at 0 degrees F. listed on the battery label.
 - b. If specific gravity readings is above 1.240 or higher with optical tester and 1.260 or higher with the hydrometer corrected to 80 degrees F.
- (6) Batteries that do not pass these requirements are to be recharged while taking specific gravity readings at 30 minute intervals until battery has met these requirements.
- (7) Batteries passing all these tests are considered serviceable batteries and are ready for issue. Turn in batteries failing the test (para 5 & 6) to DRMO for recycling or returned to your servicing contractor.

**3-16. OPERATING INSTRUCTION FOR BATTERY CHARGER
MODEL PP-1660E/U**

WARNING

Working in vicinity of a lead-acid battery is dangerous. Batteries generate explosive gases during normal Battery operation.

NOTE

It is important that each time before using your charger, you read the instruction that is issued with your charger.

Preparing batteries for charging outside of the vehicle:

1. Remove batteries from vehicle.
2. Test the state of battery (ies) charge by using the hand held battery tester or do a specific gravity test (see para. 3-8).
3. Check each battery cell to check level of electrolyte before charging add distilled water required.
4. Locate the charger as far away from the battery as DC cables will permit.
5. Make sure all switches on the charger are turned off and remove the AC cord from electric outlet.
6. Connect charger cables to battery and twist or rock back and forth several times to make a good connection or plug the NATO lead into receptacle.
7. Plug cord electric into wall outlet.
8. Check Stop/Go light *on* charger to see if green, if green connection is correct, if light is red the connection is incorrect. Change connection.

9. Set amps charge rate for size of battery and state of charge per chart following:

Battery Size Table			
Battery Size	Small	Medium	Large
Ampere Hours	40	60	80+
Reserve Capacity	60	90	100+
Cold Cranking Amps	275	350	400+

State of Charge Table				
State of Charge	15/	50/	25/	Dead
Specific Gravity	1.225	1.185	1.140	1.100
Open Circuit Voltage--6 V	6.2	6.05	5.95	5.9
Open Circuit Voltage--12 V	12.4	12.1	11.9	11.8
Open Circuit Voltage--24 V	24.8	24.2	23.8	23.6

Charge Rate VS Minutes Charge		Minutes						
Battery Size	/Charge	15	30	45	60	75	90	
Small	0-25	A	45	30	30	25	25	20
	25-50	M	30	20	20	15	15	10
	50-75	P	15	10	10	10	5	5
Medium	0-25	E	70	50	45	40	35	30
	25-50	R	45	30	25	20	20	20
	50-75	E	25	15	15	10	10	10
Large	0-25	S	90	55	55	50	45	45
	25-50		60	40	35	30	30	30
	50-75		30	20	20	15	15	15

10. Charge for length of time per charge, discontinue charge when battery has reached correct charge or if battery has tested good (para. 3-7).

NOTE

If a higher rate of charge is desired, turn the AMPs Charge Switch to the appropriate 2,3 or Hi position. Always return the AMPs Charge switch to LO position before advancing the volts charge switch.

Prepare batteries for charging in vehicle:

1. Inspect and Test Batteries (see para.3-7).
2. Make sure all accessories are turned off in the vehicle.
3. Plug in NATO Slave into vehicle receptacle
4. Plug charger in and check Stop/Go Light on charger if light is green charger is connected correct.
5. Set charger (see para. 3-16) to charge batteries and read battery charger instruction issued with equipment.
6. After charging disconnect battery charger in reverse order.

CHAPTER 4

DIRECT SUPPORT AND GENERAL SUPPORT MAINTENANCE INSTRUCTIONS

Section I. GENERAL

Referenced Information. The information contained in the preceding chapters of this manual is referenced for use during direct support and general support maintenance.

Responsibilities. Direct support and General support units have the mission responsibility to provide unit (company) maintenance with fully charged and serviceable batteries. These batteries may be new or used batteries that had been serviced and recharged.

Electrolyte Storage and Use. Only direct support units and above are authorized to stock and use electrolyte. Electrolyte is SMR coded PAFZA This means that electrolyte can be replaced at a maintenance level no lower than Direct Support. When electrolyte is unserviceable, it must be condemned and disposed of in accordance with Property Disposal Office (PDO) and Environmental Protection Agency (EPA) procedures.

Section II. MAINTENANCE PROCEDURES

4-1. Battery Shop Layout (Appx. D).

The battery shop shall be large enough to charge batteries, and add electrolyte, repair battery cases, and melt lead for forming new battery posts. Leading operations will be formed in a room separate from other battery maintenance operations, according to local SOP. The room and the leading operations shall comply with all requirements of the Occupational Safety Health Act (OSHA) for protection against lead exposure. Addition of electrolyte will be permitted only in the battery room. Repair of cracks in battery cases will be done in separate room or building equipped with a work bench and overhead exhaust hood. Addition details for battery shop layout and operation are found in this manual under Appendix D, Guidance for Local Battery Shop SOP.

4-2. Battery Shop SOP.

The battery shop will operate in accordance with the local SOP for safe operations in charging and servicing lead-acid batteries. This local SOP must be prominently displayed at the operating site. Refer to Appendix E for sample battery shop operating SOP.

4-3. Battery Repair (2HN, 4HN, 6TN only).

a. Cracks in Battery Case.

- (1) Inspect Battery For Cracks. Check for cracks on top, sides and bottom of battery case. Identify types of battery case cracks such as cracks in tops of hard top battery cases, deep cracks in battery case and/or small surface cracks in battery case.
- (2) Cracks in tops of hard top Battery Cases. Cracks in hard top batteries may be repaired using epoxy (Item 3, Appx. C). Follow the instructions furnished with the kit.
- (3) Small Surface Cracks. Small surface cracks in battery case may be repaired using the epoxy kit described above. Follow the instructions furnished with the kit.

NOTE

Large surface or deep cracks on sides or bottom of battery cases will not be repaired unless specific instructions for such repair are received from governing authority.

- (4) Cracks on sides and bottom of battery cases. Check for large surface cracks or deep cracks on sides and bottom of battery cases. Unless otherwise directed, turn in all batteries with large or deep cracked sides or bottoms.
- (5) Large Fort lift and other batteries. Large Fort lift batteries and other batteries not specifically covered by this manual shall be repaired in accordance with local policies and procedures.

b. Battery Post Repair (2HN, 4HN and 6TN Only).

WARNING

- The melting, sawing and use of pig lead must be performed in accordance with local SOP complying with OSHA requirements.
- Fumes from molten lead and dust size lead particles can be injurious to health if ingested (taken into the body by mouth or through breathing). Use protective clothing and equipment to prevent injury to personnel.
- To protect personnel from lead and acid fumes, batteries must be placed on work bench having an overhead exhaust in operation before repairing battery posts.
- To avoid danger of explosion, steps (1) through (4) below must be followed carefully. Pay special attention to step (2) below. A low battery electrolyte level creates a potential for hydrogen gas to be trapped in the battery and when subjected to open flames, sparks or other ignition sources can explode and cause injury to personnel and cause equipment damage.

(1) Remove all filler caps from battery.

(2) Make sure electrolyte level is up to ledge in filler opening. Add distilled water as necessary.

NOTE

Do not add electrolyte at this time.

(3) Let battery stand for 5 minutes to permit explosive hydrogen gas to escape and dissipate.

TM 9-6140-200-14

- (4) Battery posts that are worn or broken may be repaired or rebuilt using pig lead poured into battery post molds (Figure 4-1). The pig lead is available in 5-lb bars (Item 13, Appx. C). Battery post molds are supplied in two sizes: positive (+) post and Negative (-) post. The positive (+) post has a larger inside diameter than the negative (-) post mold.
- (5) Clean battery post. Dress down post to remove all burns, rough edges and corrosion with battery post cleaning tool (Item 3, Appx. B).
- (6) Place the battery post mold securely around the post being repaired and seat the mold to prevent the loss of molten lead from the base of the mold during the repair.

WARNING

To prevent injury to eyes, to avoid burns and to prevent explosions, wear safety goggles and gloves while working with the molten lead. Do not pour molten lead into a wet or damp mold.

- (7) For post repair, use a stick of lead approximately 1/4-inch diameter and 10-inches long. This stick can be made by melting the lead bar and pouring the molten lead into a stick mold fabricated from steel strips. Clean the dross from the top of the molded stick while the lead is still molten.

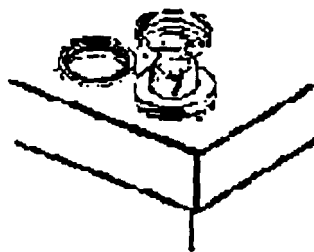

Figure 4-1

- (8) With the steel post mold securely in place, apply heat to the top of the damaged post. Use a torch that produces a narrow pencil-shaped flame in order to direct the heat to the top of the post without overheating the post mold. An overheated mold will cause the lead to become too hot and lost by running out under the base of the mold. As the lead starts to melt, be careful not to jar and unseat the mold. Use a thin steel prop and manually test the top of the lead post to determine when the post is molten enough to accept new lead to be added. This will be difficult to tell with the naked eye, and the use of the prod will help to prevent overheating of the lead. When the top of the lead post is molten, hold one end of the lead stick close over the opening of the mold. Heat the end of the stick and feed the molten lead into the molten metal of the battery post. Be sure to keep both the molten lead of the post and the new molten lead fluid until the mold is filled. (See Figure 4-2).

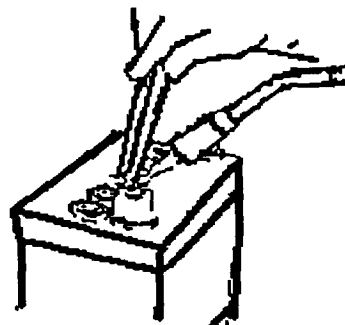

Figure 4-2

- (9) Check the newly formed post by gripping the top of the newly formed post with a pair of pliers and twisting. If the top breaks off, the lead was not sufficiently molten to complete a metallurgical bond of the old and the new lead. Repeat the operation until a bond of the two leads are complete.
- (10) If the post has been properly rebuilt, the exterior surface of the post will be smooth or bear minor roughness. Dress and clean the new post as necessary and allow the post to cure for two hours.

TM 9-6140-200-14

- c. Repair of broken or damaged battery filler ports. Repair broken or damaged battery filler ports as follows:

WARNING

Battery electrolyte can be harmful if it contacts the eyes, skin or clothing. Flush immediately with large amount of cold water. Also, in case of eye or skin contact, see a physician immediately. Wear eye/face shield and other protective clothing during all battery repair operations.

- (1) Obtain an unserviceable battery. Remove all battery filler caps and thoroughly drain electrolyte from battery.
- (2) Using a two or three hole saw, drill the unbroken filler ports and remove all undamaged filler ports from the unserviceable battery. Cut these replacement undamaged filler ports from the unserviceable so that they are large enough to overlap the holes of the battery where they will be installed by 1/4 to 1/2 inches.
- (3) Grind down the bottom side of the replacement filler ports using a disc-type grinder.
- (4) Remove the damaged filler ports from the battery to be repaired.
- (5) Thoroughly clean the battery surface where the epoxy for the replacement filler ports is to be applied.
- (6) Apply epoxy cement in small amounts to the battery surface where the repair is to be made.
- (7) Install replacement filler ports on the battery and apply epoxy cement to the outer bottom edges of the ports.
- (8) Allow epoxy to cure for at least one hour before returning battery to service.

4-4. Early Discharge of New Batteries.

- a. New batteries are often returned for charging within a few days or weeks after issue. These batteries are returned as unserviceable and are often thought to be defective when they are not. Few of these prove to be defective but, are returned because the user can find no reason for early discharge of the new battery. Failure to follow established policies and practices are common causes of early discharge of newly issued batteries. These are:
 - (1) New battery not fully charged. Installation of a partially charged new battery can not only lead to a early return for recharging but can result in short battery life.
 - (2) Failure to thoroughly clean new battery (tapered terminals and clamp terminals) connections before battery installation. Dirty electrical connections become high resistance connections and the battery terminals can overheat during high current drains. Clean battery connections are very important on voltage regulated systems.
 - (3) New battery involved in starting failure. This does not always indicate a defective or faulty new battery. Other causes of early battery discharged may be:
 - a. Insufficient equipment operating or driving time.
 - b. Worn cables, faulty or corroded cable connections.
 - c. Voltage regulator faulty or out of adjustment.
 - d. Defective alternator or generator.
 - e. Slipping drive belts, etc..
 - f. Other electrical system problems.
- b. Testing batteries for defects. Methods of testing to determine battery serviceability are as follows:
 - (1) Battery Charging. A battery which successfully takes a charge is most probably in good condition.

TM 9-6140-200-14

- (2) Battery Capacity Test. A battery discharge tester, where available, can be used to test battery capacity. If the test shows the battery to be at full capacity, the battery is probably good.
 - (3) Battery Self (Static) Discharge Test. This test should be done only in rare cases. Let the fully-charged battery stand on the shelf, static, for a period of from 3-7 days. Then test the battery to determine if the rate of standing loss due to self discharge is excessive in any battery cell. If the rate of discharge loss is not excessive in any one battery cell, the battery is in serviceable condition (See Para 4-7).
 - (4) Battery Test Conclusions. If any of the above tests show the battery to be in good condition, the test results must be accepted. This may appear obvious must be emphasized, since inexperience in the battery handling often leaves the battery handler with little understanding of the reason for a battery discharge condition. The battery is then considered unserviceable because no other reason can be found for the discharged condition of the battery. These points should always be considered when early discharge of batteries is a problem.
- c. Static Discharge During Storage. A new battery will discharge slowly when standing idle in stock. It will not, however, fully discharge in a two week period, When a new battery is returned fully discharged after only a couple of weeks, there is another cause other than a defective battery, REMEMBER, for every new battery returned for charging, many more old batteries are returned for the same reason.
- d. Testing Batteries with the hand held tester issued to battery shops:
(Read instruction for tester provided)
- (1) Simple two step testing.
 - a. Connect to battery and set Cold Cranking Amps on data plate.
 - b. Checks voltage for 12 volt batteries.

NOTE

If temperature is below 32 degrees F press and hold the temperature compensated button to get a compensated test results.

4-5 Charging Storage Batteries (Appx. B-3).

WARNING

- If for any reason acid contacts the eyes, skin or clothing, flush immediately with large amounts of cold water. Also, in case of eye or skin contact with acid, see a physician immediately.
- To avoid sparking, do not disturb connections between batteries when charging. First turn off the charger.
- Another source of explosion which may cause injury to personnel or damage to equipment is caused by the reverse connection of charging equipment. This hazard is present using some charging systems, particularly in the case of high rate charging systems. This hazard can be eliminated or minimized by careful checking of all connections before turning on the charger.
- To prevent injury to personnel or damage equipment, when charging a battery, leave battery filler caps installed and slightly loose. This will insure that the battery fill caps vents are open to prevent pressure buildup and release of battery contents.

a. Prepare Battery For Charging. Prepare battery for charging as follows:

CAUTION

To prevent contamination of existing electrolyte in the battery, be careful that dirt, grease or other debris do not enter the battery cells during battery cleaning.

- (1) Thoroughly wash all dirt and grease from the battery by using baking soda (Item 14, Appx. C) and water.
- (3) Thoroughly clean all battery posts and terminals.

TM 9-6140-200-14

- (3) Check each battery cell to insure that electrolyte is at proper level.
 - (4) If the battery is extremely cold, allow battery to warm up before checking liquid or adding distilled water. The liquid level in the battery will rise as the battery temperature increases.
 - (5) Add distilled water as required to bring the battery liquid to the proper level.
- b. Battery Charging Current. Only direct current from a controlled charging source should be used for charging batteries. This will insure that the charging rate of the battery is not excessive.
- c. Connections for Battery Charging. Connections used for battery charging are of two types: series, parallel or direct individual battery connections to the charging source. The type of connection made will depend on the type of charging system used and is described below.
- (1) Parallel battery connections. These connections are used with high rate battery charging systems. High rate chargers are usually of the constant voltage type which require that batteries be connected in parallel. The number of batteries that may be connected in parallel depends on the current capacity of the charger. All batteries connected to the high rate charger must be of the same voltage rating. The parallel connections will have all terminals of like polarity connected- the positive (+) cable of the charger connected to the positive connection of the batteries and the (-) negative cable of the charger connected to the negative connection of the batteries. Hookup and charging operations shall be in accordance with the printed instructions of the manufacturer of the high rate battery charger. (Figure 4-3)

NOTE

Battery charger may be different than the one shown.
Read battery charger instruction that is overpacked
With battery charger before connecting charger to
Batteries for charging.

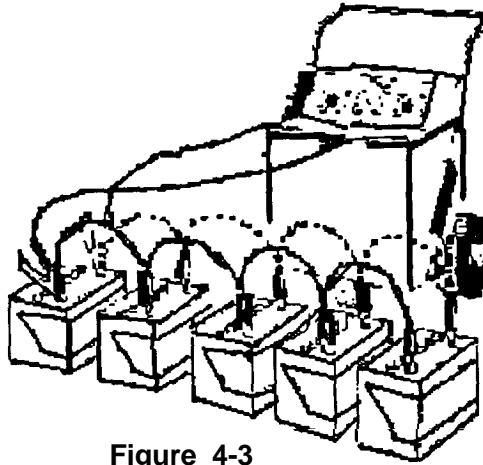

Figure 4-3

- (4) Series battery connections. These connections are used with slow rate of charging systems. Slow rate chargers are of constant current type allowing series connections between the charging unit and the batteries. The number of batteries that may be connected in series to this charging unit depends upon the voltage rating of the charger. The series connection will have the negative (-) terminal of one battery connected to the positive (+) terminal of the next battery. When all batteries of the group are connected, the cables of the charger are connected to the remaining negative (-) and positive (+) battery terminals accordance with the written instructions of the manufacturer for the charger used. Perform all charging operations in accordance with the charger manufacturer instructions. (Figure 4-4)

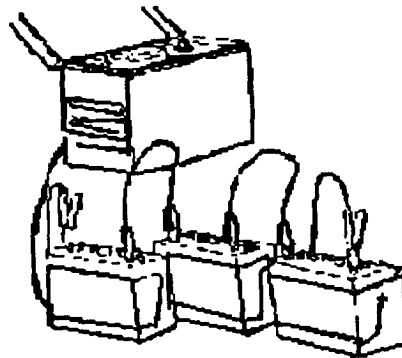

Figure 4-4

WARNING

To prevent injury to personnel or damage to equipment, the battery gas volatility descriptions below should be brought to the attention of all battery maintenance personnel and similar statements posted where battery maintenance is performed.

d. Battery Gases Are Explosive.

- (1) Battery Gases During Charging Operations, When a battery is being charged, it releases a mixture of hydrogen and oxygen gases. These gases can explode if a spark or flame is brought too near the charging battery. Any room or compartment where charging batteries are confined should be well ventilated. Do not allow flames or sparks near filler cap vent openings.

NOTE

If a new recharged battery shows a difference of more than 0.025 specific gravity between cells, the battery is unserviceable.

- (2) Static Battery Gases. Small quantities of hydrogen gas are given off at negative plates of lead-acid batteries, even when the battery cells are not being charged. It must, therefore, be assumed that explosive mixture of hydrogen gas are present within and around battery cells at all times. A torch, match, flame, lighted cigarette, or any spark from metal tools accidentally contacting the battery terminals, could cause ignition of these gases.

4-6. Battery Specific Gravity Differences.

State of charge as indicated by specific gravity when discharged at reserve capacity rate.

State of Charge*	Specific Gravity Cold Temperature Climates
Fully Charged	1.280
75% Charged	1.250
50% Charged	1.220
25% Charged	1.190
Discharged	1.100

4-7 Allowable Difference Between Cells.

If a fully charged battery shows a difference of more than 0.025 specific Gravity between any two cells, the battery is unserviceable.

4-8 Storage of Wet-Charged Batteries.

- a. Preparations for Storage. The electrolyte level for fully charged batteries of standard construction is approximately 3/8 inch above the top of each cell separator (level ring in battery) when the battery temperature is 80 degrees Fahrenheit. In very cold batteries, the electrolyte level will be lower than normal. Cold batteries should be allowed to warm up before electrolyte level is checked. Batteries to be stored will be fully charged to the rate specified in paragraph 4-6 before storage.
- b. Rotation of Stored Batteries.
 - (1) New batteries should be stored in a manner which will allow the oldest batteries stored to be placed into service first. A battery will discharge at a slow rate during storage and may require a charge before being placed into service. Store batteries so that they can be reached for charging without moving more recently stored units.

TM 9-6140-200-14

- (2) Separate and store batteries by type, date received and date stored. Mark the date the battery is received on the battery casing with chalk. This will help in placing the oldest battery stored in service first.
- (3) Do not stack batteries in storage for battery storage methods and instructions (see para. 3-5).
- (4) Batteries in shipping cases should be stored on elevated pallets.
- (5) Remove and inspect all batteries received in broken or damaged shipping containers. If batteries are not damaged, store in good containers. Repair or turn-in all damaged batteries.

c. Self-Discharged of Wet-Charged Batteries. (6TL, 2HN and 4HN)

- (1) All wet-charged batteries will discharge slowly in storage. These batteries may discharge faster when fully charged than when partially charged. Temperature has an important effect on the self-discharge of wet-charged batteries. A warm battery will self-discharge much faster than a cold battery. Listed below is the approximate self-discharge rate of the average, fully charged battery, in good condition for the first 10 days of storage due to temperature conditions:

At 100 degrees Fahrenheit 0.0025 specific gravity/day

At 80 degrees Fahrenheit..... 0.001 specific gravity/day

At 50 degrees Fahrenheit.....0.0003 specific gravity/day

- (2) To minimize the rate of self-discharge, store wet-charged batteries in as cool place as possible. Store all batteries away from hot air ducts and radiation heating units. Shield stored batteries from direct sunlight at all times.

- d. **Boosting Charge of Stored Batteries.** A boosting charge can be used to make up for a loss of charge while a battery is in storage. The stored battery should be given a boosting charge whenever the specific gravity drop is more than 0.040 corrected to temperature of 80 degrees Fahrenheit. Care shall be taken not to give the battery an excessive charge during boosting. The boosting charge should be applied whether the battery is to remain in storage or is to be issued. This will normally occur about every 30 days in warm weather and may be less frequent in cold weather. Before applying the boosting charge, the electrolyte level should be checked. Add distilled water as necessary to bring cells to proper liquid level.
- e. **Date Marking Charged Batteries.** Mark the date of charged or recharged on the batteries charged while in storage. This will help to determine batteries ready for issue and batteries still requiring a charge. The date of the charge or recharge can be marked in chalk on the battery casing in a manner and location that will prevent the date from being easily erased.

4-9. Storage of Dry-Charged Batteries.

- a. **Advantages of Stored Dry-Charged Batteries.** Unlike wet-charged batteries, dry-charged batteries do not undergo serious deterioration, sulfating or corrosion during storage. The dry-charged battery can lose a charge during long storage periods due to moisture intake without harmful effects. Filling the battery to proper electrolyte level and bringing it to a full-charged state makes it, fully-charged battery.
- b. **Negative Plate Oxidation Check.** The negative (-) plates of a dry charged battery can become oxidized by the intake of moisture during storage. The degree of oxidation to the negative (-) plates will determine the length of charge time and the degree of charge required to bring the battery to a fully charged state. The following steps should be used to determine if a dry-charged battery has oxidized negative(-) plates:
 - (1) Obtain proper electrolyte package for use with battery.
 - (2) Check specific gravity and temperature of electrolyte.
 - (3) Fill the battery with the electrolyte and let stand for 20 minutes.

TM 9-6140-200-14

- (4) Recheck the battery electrolyte for specific gravity and temperature.
- (5) Note the difference in readings between steps (2) and (4) above.
- (6) Charge battery to a fully charged state.

4-10. Placing Dry-Charged Battery in Service.

NOTE

This is a dry-charged, lead-acid battery. When placing into service, identify the "in-service" Month/Year by removing the proper tabs from the permanent label on the top of the battery.

CAUTION

Do not remove sealing devices until ready to fill battery.

- a. Remove and dispose of any sealing devices which seal each of the battery cells during shipment and storage.
- b. Remove vent caps and fill each cell with the over-packed electrolyte (only) to the bottom of cell opening. Temperature of the battery and electrolyte must be above 60 degrees F. (15.5 C), but preferably not above 100 degrees F (37.8 C.).
- c. After filling to the proper level, allow the battery to stand for at least 2 hours (required), or 24 hours (preferred/recommended). Check and record electrolyte specific gravity of each cell, correcting the reading to 80 degrees F (26.7 C.).
- d. Add electrolyte, if necessary, to bring fluid level in each cell to the proper, indicated level.

NOTE

After filling battery, install and finger tighten vent/filler caps. Rinse container at once but it is desired rinse three times with baking soda and water. You may dispose of as trash.

e. CHARGING BATTERIES:

1. Charge battery for 2 1/2 hours (required). Follow battery charger instructions for proper connection.
2. Allow battery to stand for at least 2 hours (preferably 24 hours) after charging, then check battery specific gravity and/or voltage. If within limits (as specified below), issue for use.
 - (a) Voltage 12.5 volts or higher by using the hand held battery tester.
 - (b) Temperature corrected specific gravity reading 1.230 or higher by using the optical tester.
 - (c) Temperature corrected specific gravity reading 1.260 or higher by using the a hydrometer.
3. If battery is not within limits listed above, continue (re)charging and check battery at 30 minutes intervals until voltage or specific gravity remains constant.
4. If the battery still fails to reach the required minimum values after a total of five (5) hours of charging, it is defective and must be turned in or disposed of according to local procedures.

NOTE

After the battery has been charged for the first time DO NOT add electrolyte, Add distilled water only to bring level to the bottom of the cell opening.

5. After charging and testing battery for issue, clean battery with baking soda and water.
6. For recharging and maintaining the battery after activation, use this manual for instructions.

TM 9-6140-200-14

7. Charge each battery being placed into service. Charge battery at an ampere rate of 3 to 5 amperes (2HN, 4HN and 6TN types) and the charging rate of 5 amperes or 15 volts constant potential voltage to the 6TL.
8. During the charging process, maintain the electrolyte temperature at maximum of 130 degrees Fahrenheit by charging the charging the battery at a normal rate. Reduce the charging rate if the temperature increases. if necessary, disconnect the hot battery from the charger or turn off the charger until the battery is cooled.

4-11. Battery Electrolyte Specific Gravity Test.

This test is used to determine the approximate state of charge and how much energy is available from the battery.

WARNING

Battery electrolyte is an acid. Severe burns may result. Take precautions to avoid contact with eyes or skin.

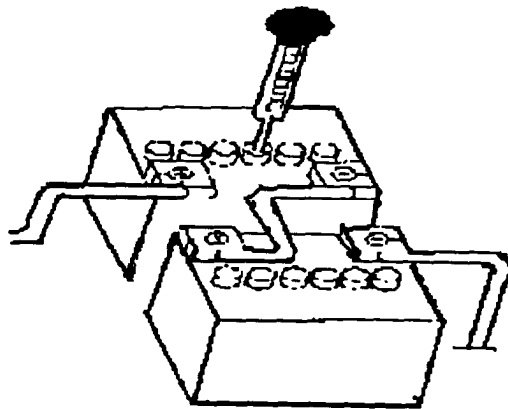

Figure 4-5

- a. Use an hydrometer and draw enough fluid from battery cell to allow indicator to float freely (see Figure 4-5).

- b. Read indicator with your eye located approximately level with fluid. Note reading.

NOTE

- o Readings taken while looking at the indicator from a sharp angle are very inaccurate.
 - o If a new or recharged battery shows a difference of more than 0.025 specific gravity between cells, the battery is defective
- c. Test all cells of the battery and note readings. Allowable high -to- low difference in readings between cells shall be 0.025 points maximum.
- d. At 80 degrees Fahrenheit electrolyte temperature each cell of a fully charged battery should read 1.280 maximum. At 80 degree Fahrenheit a battery is discharged if it reads less than 1.220.



CHAPTER 5

SEALED LEAD-ACID BATTERY (GEL)

5-1 Putting into Operation.

NOTE

Sealed lead-acid batteries are delivered already filled and charged.

In this state they can be stored for 24 months. They must be put into operation before the end of this period, at the latest.

The sealed batteries and must remain sealed, and should not be opened as this will damage them.

The batteries are pre-filled and pre-charged. They contain enough electrolyte to last their life time.

Do not try to check the level of the electrolyte, or add distilled water.

5-2 General Instructions.

1. Because of the 24 volt system in military equipment, batteries are used in sets consisting either of 2 units connected in series, or 4, 6, or 8 batteries connected in series/parallel resulting in a nominal voltage of 24 volts.
2. If sealed the individual batteries must be the same type to allow this battery set to operate correctly and not degrade its service life.

WARNING

Do not use open and sealed lead-acid batteries together in one set of batteries. May cause damage to equipment.

NOTE

- Never integrate a new battery into an old battery set. It is more economical to replace the complete set of batteries and use the removed and still serviceable batteries for other purposes.
- Before making the electrical connection carefully clean the connectors and connection cables using a suitable tool. In particular, remove all remnants of grease.
- The vehicle master on/off switch must be selected to “OFF” when installing and removing any batteries.
- Before installing sealed lead-acid batteries inspect the battery holders and battery boxes for damage; repair as needed.
- The battery’s first date used must be shown by the 4-figure code on the battery lid, e.g., 0683 for June 1983.
- All sealed lead-acid batteries in one set should have the same put in service date.
- Check the battery at 6 month intervals with the aid of the lead-acid battery tester (Item 22, Appx. B).
- Do not use a lead acid battery charger to charge GEL batteries.

5-3 Battery care.

1. To insure that the battery is ready to operate and in a functional state. Do the following actions:
 - a. Visually inspect the battery posts, battery filler caps and for external damage, e.g. cracks in the battery case.
 - b. Clean batteries, as required, (see Chapter 3).
2. Replace the battery if posts are burnt or damaged in any other way.
3. Insure that “filler caps” are not covered by paint, grease or anything similar substance.

NOTE

- The battery is to be cleaned with clean rags, if necessary use luke warm water with small amount soap/detergent.
- Do not clean the battery with abrasive cleaning agents or diesel oil. These materials can damage the plastic battery case.
- Cleaning the battery posts with a brass-wire brush or with the special tool intended for this purpose.
- Do not grease the terminal poles.

5-4 Replacing open lead-acid batteries in vehicles and equipment with sealed lead-acid batteries.

1. Most military vehicles use batteries in sets connected in series-parallel.
2. A battery set of this kind can only function properly if each individual battery is of the same type.
3. To achieve maximum battery life every effort should be made to install from the same manufacturer and with the same release date.
4. It is best to replace the complete battery set, even when only one battery in the old set is defective. The serviceable batteries from the old set can be used for other purposes.

NOTE

- Do not mix vented and sealed lead-acid batteries in one vehicle,
 - When replacing all open lead-acid batteries with Sealed Lead Acid batteries replace as a set. Do not mix.
 - Since the sealed lead-acid battery's is " maintenance free" its periods between inspection are longer. It is necessary to clean the battery compartment and carefully make the electrical connections before installing sealed lead-acid batteries.
 - The same applies to accurate adjustment of the voltage regulator; The voltage regulator must operate in the band applicable to the vehicle or equipment concerned. The aim should be to attain the lower voltage tolerance limit (see equipment TM).
 - Do not believe that increasing the voltage brings any advantages. Quite the opposite is true. The batteries will be over-charged or fail prematurely.
5. When open lead-acid batteries are to be replaced by sealed lead-acid batteries, carry out the following action in the order given.
- a. Remove open lead-acid batteries; check with lead-acid battery tester (item 20 or 22, Appx. B) to determine whether they are suitable for other possible uses.
 - b. Use the same voltage values to assess criteria for corresponding types of battery.
 - c. Thoroughly clean the battery compartment and hold downs. Repair or replace any damaged parts. Thoroughly clean and remove any residual grease.
6. Put the sealed lead-acid batteries into operation (see paragraph 5-1).
7. Install the sealed lead-acid batteries.

8. Carefully connect the batteries in the vehicle or the equipment (refer to paragraph 5-2) see vehicle/equipment TM.
9. Do not grease the battery posts and cables clamps. Treat the terminal posts and exposed connection pieces with a silicone spray (Item 20, Appx. C).
10. Start the engine; measure the voltage at the battery posts with the engine running.

NOTE

- If necessary, adjust the vehicle/equipment voltage as specified by the applicable maintenance TM.
 - Sealed lead-acid batteries in the form of block batteries, such as the NBB 248, cannot be repaired. If they suffer damage or fail to reach the required electrical values remove from service.
11. If the vehicle is equipped with or operated with an auxiliary electrical generating unit, then the output voltage of this unit must be checked on the battery posts. Correct the voltage if necessary (see para 10 above).
 12. The use of sealed lead-acid batteries have the following advantages over open lead-acid types:
 - a. Freedom from maintenance in respect of checking the electrolyte and topping it off with distilled water.
 - b. Are more capable for withstanding deep-discharge.
 - c. No electrolyte spillage, even in the event of mechanical damage.

5-5 Long-Term Parked Vehicles (Stored longer than 6 months).

1. In this mode of operation it is assumed that a vehicle is temporarily removed from service, with the batteries connected.

TM 9-6140-200-14

2. The vehicles may be stored successfully if:
 - a. The battery was activated within 24 months of manufacture.
 - b. If battery was properly activated and installed (see paragraph 5-1).
 - c. The battery is less than 5 years old. (The first date of operation must be crossed out on the decal provided on the battery)
 - d. It is checked at 6 month intervals with the aid of the lead-acid battery tester (see chapter 3 for unit level and chapter 4 for Direct Support).
 - e. Recharge the batteries every three (3) months by allowing the engine to run between 1000 and 1200 RPMs for at least 20 minutes. (see local SOP and TM).

NOTE

Recharging the batteries by running the engine is the simplest solution. The best solution is to recharge by using a suitable battery charger.

5-6 Charging Sealed Lead-Acid Batteries.

5-6.1 General.

- a. The purpose of a battery is to store electrical energy and have it available when needed.
- b. All rechargeable batteries used by the U.S. Armed Forces are basically charged according to two different techniques:
 - (1) Constant current charging (I-characteristic).
 - (2) Constant voltage charging (U-characteristic),

- c. The constant voltage method is the most suitable for charging sealed lead-acid batteries. Though not as good, constant current charging method can be used. This method must remain an exception, and be used only when no constant voltage charging devices are available.
- d. In constant voltage charging, the charger maintains a constant applied voltage to the battery.

5-6.2 Recharging.

- a. Recharging is necessary to bring sealed lead-acid batteries which has stood for 12 months to a usable state of charge.
- b. Charging Procedures for GEL Battery (NBB248), Do not charge more than one battery at a time.

NOTE

The best way to determine how fully charged a GEL battery is by a simple voltage reading on the rested battery.

- (1) The approximate relation of battery state of charge to battery open circuit voltage (OCV) is shown below.

Open Circuit Voltage	State of Charge
12.9 volts	100%
12.7 volts	75%
12.4 volts	50%
12.1 volts	25%

CAUTION

Use only battery chargers appropriate to charge GEL batteries, restricted to 14.1--14.4 volts maximum. Any other battery charger will shorten the life of the battery and cause internal damage.

- (2) Charge GEL batteries (NBB248) in accordance with the time, state of charge and the initial output (Amps) of the charger. See table below:

Battery State Of Charge	Approximate time in hours required to Full Charge at 14.4 volts (Charger Output in Amps)		
	40 Amps	20 Amps	10 Amps
10%	5.0 hours	6.0 hours	9.0 hours
30%	3.0 hours	4.0 hours	7.0 hours
50%	2.0 hours	3.0 hours	5.0 hours

- (3) After charging let stand for 3 to 10 hours to dissipate surface charge and test voltage IAW Paragraph 1a above.

NOTE

Do not charge GEL batteries when temperature exceeds 122 degrees F. (50 C). Also, Do not charge GEL batteries below 41 degrees F. (5 C.) because of the slow reaction and lengthy recharging times (up to 60% more).

5-6.3 Initial Charging.

- a. The initial charging operation, fully charges batteries.
- b. Full charging takes longer than top-up recharging.

5-6.4 Trickle Charging.

- a. Trickle charging is a method of charging for maintaining a battery that is already at a good state of charge.
- b. Trickle charging primarily compensates the self-discharge losses suffered by all rechargeable batteries during storage.
- c. Possible types of operation and application for trickle charging in the military sphere are as follows:
 - (1) Switch-over operation
 - (2) Mothballed vehicles
 - (3) Batteries which must be kept in a good state of charge for a special operation needs.

5-7 Parallel Charging of Batteries with Constant Charging Voltage.

- a. This method of charging brings several batteries up to a satisfactory state of charge with the aid of a battery charger.
- b. Sealed Lead-acid batteries can be charged in this form if they have the following:
 - (1) different states of charge.
 - (2) different ages.
 - (3) different rated capacities.

TM 9-6140-200-14

- c. As a pre-caution ensure that all batteries to be charged have the same rated voltages, and that the constant charging voltage is matched to this rated voltage. The charging voltage must be selected as follows:

13.5 volts to 14.5 volts for batteries rated at 12 volts

NOTE

Note the total loading current of the charger. When it registers to 1% of the total capacity of the connected batteries, then all the batteries are fully charged.

5-8 Vehicle Power System Charging.

- a. By vehicle power system charging we mean the recharging via on-board power systems, e.g., via the external starting sockets of tactical vehicles (Nato Connector).
- b. This form of recharging is possible without taking special measures. However, it is necessary for the battery voltage to match the vehicle's system voltage as follows:
 - (1) 12 volt batteries can be charged from 12 volt vehicle systems.
 - (2) 24 volt batteries and battery sets consisting of 12 volt batteries in series-parallel can be charged from 24 volt vehicle systems.

5-9 Withdrawal From Use and Storage.

- a. Sealed lead-acid batteries have very low self-discharge rates.
- b. They must be stored in the fully charged condition.
- c. No special storage conditions are needed for these batteries, although the storage room should be cool and dry.

- d. The storage temperature can lie between 5 degrees Fahrenheit (- 15 degrees Celsius and + 149 degrees Fahrenheit (+ 65 degrees Celsius), However high storage temperatures are as undesirable because they promote increase self-discharge.

CAUTION

If storage temperature below 32 degrees Fahrenheit (0 degrees Celsius) are to be expected it is essential to ensure that the state of charge is always greater than 50%.

If the battery charge is below 50% there is a risk of damage or destruction as a result of the electrolyte freezing.

- e. When a sealed lead-acid battery is taken out of service and is stored for a long period, carry out the following actions in the order given:
 - (1) Service the battery (see paragraph 5-2).
 - (2) Recharge (see paragraph 5-6.2).
 - (3) Attach a label to the battery showing the date on which it was taken out of operation.
 - (4) During the storage period recharge the battery at 12- monthly intervals in accordance with paragraph 5-6.
 - (5) To place back into service after storage proceed as in paragraphs 5-1 and 5-3.

5-10 Transportation.

NOTE

The lead-acid batteries are very heavy, and must be restrained to ensure they remain properly stowed if subjected to sudden acceleration or braking.

- a. Sealed lead-acid batteries are filled with electrolyte and are supplied and stored as “filled and charged batteries”. It is not necessary or possible to fill them with water when they are first put into service.
- b. This special feature unlike open lead-acid batteries containing liquid sulfuric acid, sealed lead-acid batteries need not to be regarded as “electrolyte containers” to which special hazard regulations apply.
- c. However, to avoid short circuits, sealed lead-acid batteries should be transported in packed condition, use cardboard cartons belonging to a particular type is to pack.

5-11 Withdrawing From Service and Disposal.

- a. Batteries using gelled electrolyte need no special measures when withdrawing them from service and disposal.
- b. Dispose of batteries withdrawn from service in accordance with local, EPA and State Regulations.

CHAPTER 6

BATTERY DISPOSITION AND DISPOSAL

6. Battery Disposition and Disposal.

6-1 Purpose and Scope.

This chapter establishes a general procedure for disposition and disposal of damaged, defective or unserviceable lead-acid batteries. This chapter applies to all lead-acid batteries used in military equipment managed by the U.S. Army Tank-automotive and Armaments Command. This chapter does not apply to air shipment of unserviceable batteries for disposition refer to Air Force Regulation 71-4 and TM 38-250, "Preparing Hazardous Material For Military Air Shipment". Refer to SB 11-6 for serviceable batteries.

6-2 General Requirements.

- a. This chapter provides solid waste characterization guidance under Resource Conservation and Recovery Act (RCRA) regulations. The guidance and procedures in this chapter are consistent with US Environmental Protection Agency (EPA) and Department of Defense (DOD) policy. This chapter will aid in complying with environmental solid waste requirements. Readers must also ensure compliance with state regulations in effect when disposing of batteries. This chapter does not supersede or take precedence over any regulations or other official directives. If there is a conflict between this chapter and regulations or DOD directives, you must follow appropriate regulations and directives.
- b. Foreign, state and local regulations may be more stringent than the procedures in this chapter. It is necessary to coordinate with appropriate officials at your installation/activity to ensure that disposition and disposal actions comply with existing regulations and policies (see para. e. below).

TM 9-6140-200-14

- c. In accordance with DOD Directive 6060.16, DOD Policy for Establishing and Implementing Environmental Standards at overseas Installations, the U.S. Air Force (USAF) is the DOD Executive Agent and has the responsibility for establishing guidance/standards for the disposal of hazardous material/waste at OCONUS (outside of continental United States) Installations (Refer to e below).
- d. The local Installation/Unit Environmental Office/Officer (IEO) must coordinate with the local servicing Defense Reutilization and Marketing Office (DRMO) and advise all affected units of local procedures for management of batteries as hazardous material (HM) and/or Hazardous Waste (HW). Manifesting under Title 40, Code of Federal Regulations (CFR), part 262.20 may be required. The requirements for manifesting will be IAW Federal, State and Local regulations. When affected units are at a remote site, the IEO will coordinate with the remote site Environmental Official to ensure proper management of batteries.
- e. Coordinate all disposition and disposal of batteries with:
 - (1) Local Installation Environmental Office (IEO) to ensure conformance with environmental regulations.
 - (2) Local DOD Executive Agent (DODEA) through your local IEO to ensure conformance with environmental regulation at OCONUS locations.
 - (3) Local Servicing Defense Reutilization Office (DRMO) to ensure conformance with DOD disposition/disposal policies.
 - (4) Local Installation Transportation Office (ITO) to ensure conformance with transportation regulations.
 - (5) Supporting Safety Office/Officer (SO) and/or Industrial Hygienist (IH)/Preventive Medicine Office/Officer (PMO) to ensure safe handling and for coordination of personnel protection equipment (PPE), when recommended.

6-3 Characterization of Batteries.

CAUTION

Personnel protective equipment (PPE) must be used when handling batteries (See Appendix C).

Lead-acid batteries are classified as hazardous waste (HW) under the Federal Resource Conservation and Recovery Act (RCRA), administered by the US Environmental Protective Agency (EPA) or under state regulation and must be disposed of through your servicing Defense Reutilization and Marketing Office (DRMO) or via local contract.

6-4 Handling.

- a. Hot/warm battery (ies) may vent or rupture. Do Not handle hot/warm batteries. Wait until they have cooled to touch.
- b. Inspect batteries for obvious physical damage or defect prior to use. Do not use defective batteries.
- c. Do Not short circuit batteries.
- d. Do Not over-charge batteries. Remove battery (ies) from equipment immediately after they fail to operate the equipment.
- e. Use only the correct batteries authorized by the equipment Technical Manual.
- f. Do Not use any battery which does not easily fit into the battery compartment.

6-5 Special Requirement.

- a. General.
 - (1) Batteries should be kept cool and dry and away from open flame, heat, and combustibles, in a well ventilated area with temperature not to exceed 130 degrees Fahrenheit (54 degrees Celsius) when stored.
 - (2) Protect batteries against being damaged, crushed, punctured or short circuited.

TM 9-6140-200-14

- (3) Do not smoke or eat in battery storage area.
- (4) Store batteries separately from other hazardous material.

6-6 Transportation.

Shipment of batteries within the United States over public roads must be IAW Federal DOT requirements (Title 49 CFR, Part 172.101, Hazardous Material Table (HMT) when batteries are listed in the HMT. The regulation includes packaging, marking and labeling requirements.

6-7 Disposition and Disposal.

In Accordance With DOD consolidated Hazardous Material/Hazardous Waste Disposal Guidance, batteries designated as HW for disposal may be disposed of via the local servicing DRMO. In addition, HW may be disposed via local contract. Disposal of HW via local contract must be coordinated with and approved by HQDA, Office of the Directorate of Environmental Programs (ENVR-E), prior to finalization/signature of the local contract. All disposition/disposal actions must be IAW Federal, State, and Local regulations and requirements. Coordinate all actions with the local IEO to ensure proper management of unserviceable batteries.

a. Disposition and Disposal.

- (1) For any turn-in of HW (hazardous waste) Profile Sheet (HWPS) DRMS Form 1930 is required. If a HWPS is required for turn-in of HW. Data from this chapter may be used in completion of the technical data.
- (2) If batteries or battery electrolyte for disposal are managed as HW and you must transfer/transport the batteries off your installation, you are required to manifest these waste batteries under title 40 CFR Part 262 regulations. Consult your local IEO for guidance about manifest requirements.
- (3) Batteries designated as HW for disposal, and electrolyte from vented lead-acid batteries, may be disposed via the local DRMO or via local contract.

- b. Recycling.
 - (1) Recycling and/or reclamation is the recommended option for disposition of batteries in lieu of disposal. Lead-acid should be considered for recycling or reclamation based on federal and state requirements.
 - (2) Some batteries identified as HW may be recycled under RCRA regulations, and therefore managed as HM.
- c. Transfer to the Defense Reutilization and Marketing Office (DRMO).
The DRMO will accept accountability provided the batteries are properly marked, labeled, packaged and turned in with appropriate documentation. The DRMO will accept physical custody depending upon the availability of conforming, or most nearly conforming, storage areas.
- d. For additional information on the disposal of HW, beyond the scope of this chapter, refer to Technical Guide (TG) No. 126, "Waste Disposal Instructions" TG. 126 can be obtained from your local IEO or PMO, or contact USEHA, Waste Disposal Engineering Division at DSN 584-3651 or commercial (410) 671-3651.

6-8 Lead-acid (LA) Battery Profile.

Lead-acid batteries are secondary (rechargeable) batteries. There are three kinds of LA batteries: sealed batteries without vented filled caps, and vented batteries with vent filled caps for servicing the batteries.

- a. Chemical Characterization.
 - (1) Anode: Lead (Pb)/ lead Sulfate (P6SO4) on a lead alloy grid.
 - (2) Cathode: Lead dioxide (PbO2)/ lead Sulfate (P6S04) on a lead alloy grid.
 - (3) Electrolyte: Aqueous solution of sulfuric acid (H2SO4).

TM 9-6140-200-14

- (4) The battery cell contains 60 to 75 percent Pb and PbO₂ by weight. The battery cell contains an acidic electrolyte solution of between 28.3% and 50.5% H₂SO₄ by weight.
- (5) Pb and Pb salts are toxic and hazardous materials. It is recommended to turn-in LA batteries wet. If you must drain the battery, test H₂SO₄ electrolyte for Pb prior to disposal. If Pb is below the RCRA regulatory limit (5.) Mg/L, then the electrolyte may be disposed in accordance with TG No. 126 with the concurrence of the IEO and the affected waste water treatment authority.

b. Solid Waste Characterization.

- (1) Under federal RCRA: HW with a Environmental Protection Agency (EPA) HW number (EPA HW#) of D008 for Pb.
- (2) Bioassay findings: Not tested. Or summed to be toxic based on Pb content.

c. Handling (see Para 5.5).

WARNING

- Do not use metal or galvanized equipment when draining electrolyte from Lead-Acid batteries.
- Do not use finely divided combustible materials (e.g., sawdust) to absorb an H₂SO₄ is highly reactive and can react with finely divided combustible material on contact.
- Do not attempt to drain electrolyte from sealed secondary batteries.
- Do Not drain electrolyte from vented secondary batteries unless authorized.

WARNING

- If H₂SO₄ electrolyte spills or leaks, Do Not touch spilled material. Stop the leak if you can do it without risk. Spread sand or other noncombustible material, then flush 15 minutes with Baking soda and water. Notify the local SO and IEO.

d. Storage.

WARNING

- If battery content or electrolyte comes in contact with the skin, IMMEDIATELY flush the affected area for at least 15 minutes with clean water and seek medical attention promptly.
- Do Not use water on fires involving H₂SO₄ is highly reactive and can react with finely divided combustible materials (e.g., saw dust) on contact. Small fires may be extinguished with a dry chemical extinguisher approved by the local fire department. A CO₂ fire extinguisher is recommended.

CAUTION

Batteries should be protected from freezing. Battery electrolyte should not be drained from vented LA batteries, unless the battery cannot be protected from freezing. Refer to the table below for freezing points. Refer to the appendix in the back of this chapter for instructions if batteries need to be drained.

1. Protect batteries against being damaged, crushed, punctured or short circuited.
2. Store batteries separately from other hazardous material.
3. Batteries should be kept cool and dry, and away from open flame, heat and combustibles, in a well vented area with temperatures not to exceed 130 degrees F (54 degrees C).

Freezing Points of Solutions of Sulfuric Acid

Specific Gravity	Celsius	Freezing Points Fahrenheit
1.000	0.0	+32.0
1.050	-3.3	+26.0
1.100	-7.7	+18.0
1.150	-15.0	+5.0
1.200	-27.0	-17.0
1.250	-52.0	-61.0
1.300	-70.0	-95.0

e. Disposition and Disposal.

NOTE

Do Not accumulate and store batteries for disposal for more than 90 days.

- (1) Dispose of LA batteries as HW under federal RCRA regulations. Disposition may be through your local serving DRMO or via local contract.
- (2) LA batteries may be recycled under provisions of Title 40, CFR, Part 266.80. Many states ban land disposal and regulate recycling of LA batteries.
- (3) In states with bioassay requirements, LA batteries are classified as HW, and disposition/disposal may be through your local servicing DRMO or via local contractor.

6-9 Reference

- a. Department of the Army (DA) Pam 385-3, Protective Clothing and Equipment, May 76.

US Army AG Publications Center
2800 Eastern Boulevard
Baltimore, Maryland 21220
Telephone: DSN 584-2533 or Commercial (301) 671-2533

- b. Department of Defense (DOD) Manual 4160.21-M, Defense Utilization and Disposal Manual.
- c. DOD Consolidated Hazardous Material/Hazardous Waste Disposal Guidance, June 1981.
- d. U.S. Department of Transportation (DOT) P5800.X, "Hazardous Material Emergency Response Guidebook."

US Department of Transportation
Office of Hazardous Material Transportation/DHM 51
Research and Special Program Administration
400 7th Street, SW, Washington, DC 20590
Telephone: Commercial (202) 366-2301

- e. General Services Administration (GSA) Supply Catalog, Office Products, Industrial Products Tools, Furniture.

GSA Centralized Mailing Lists Services
PO Box 17077
819 Taylor Street
Ft. Worth, Texas 76102-0077
Telephone: DSN 739-7369 or Commercial (817) 334-5212

- f. Message, DRMS_HT< HQ Defense Reutilization and Marketing Service, DGT 141855Z May 1986, Subject: Turn-In Procedures for Disposition of Batteries.

TM 9-6140-200-14

- g. SB 38-100, Preservation, Packaging, Packing and Marking Materials, Supplies and Equipment Used by the Army, March 1978.

US Army AG Publication Center
1655 Woodson Road
St Louis, MO 63114
Telephone: DSN 693-7305

- h. Title 40, Code of Federal regulations (CFR), Parts 260-266.

Superintendent of Documents
US Government Printing Office
Washington, DC 20402
Telephone: (202) 783-3238

- i. Title 49, CFR, Parts 172 and 173.

Superintendent of Documents
US Government Printing Office
Washington, DC 20402
Telephone: (202) 783-3238

- j. U.S. Army Environmental Hygiene Agency (USAEHA) Technical Guide (TG) No. 126, Waste Disposal Instructions.

- k. Vinal, G.W., "Storage Batteries", A General Treatise on the physics and chemistry of secondary Batteries and their Engineering Applications," 4th Ed., John Wiley & sons, Inc., London, 1962.

Commander
US Army Environmental Hygiene Agency
ATTN: HSHB-ME-SH
Aberdeen Proving Ground, MD 21010-5422
Telephone: DSN 584-3651 or Commercial (401) 671-3651

- l. DOD Directive No. 6050.16m ASD (P&L), 20 September 1991. Subject: DOD policy for Establishing and Implementing Environmental Standards at overseas Installations.

TM 9-6140-200-14

- m. Supplement, DASD (Environmental), 25 October 1991, Subject: DOD Policy for Establishing and Implementing Environmental Standards at overseas Installations (DOD Directive 6050.16).
- n. Attewell, A. et. Al., "Handbook of batteries and Fuel Cells," D. Linden, Ed., McGraw-Hill Publishing Co., New York, NY
- o. ANSI Z 41-1991, "Safety-Toe Footwear, NA," American National Standards Institute (ANSI), New York, NY
- p. Supply Bulletin (SB) 43-01345, Battery Disposition and Disposal, dated 1 July 1993.

Commander
USA CECOM
ATTN: AMSEL-SF-REE
Ft. Monmouth, NJ 07703-5024

- q. AFR 71-4 (TM38-250) "Preparing Hazardous Materials For Military Air Shipment".

American National Standards Institute Sales Department
1430 Broadway
New York, NY 10018
Telephone: Commercial (212) 642-6900

- r. International Maritime Organization (IMO), "International Maritime Dangerous Goods Program".

American National Standards Institute Sales Department
1430 Broadway
New York, NY 10018
Telephone: Commercial (212) 642-6900

TM 9-6140-200-14

- s. DRMS-M 6050-1) "Environmental Compliance for the DRMS Hazardous Property Program".

American National Standards Institute Sales Department
1430 Broadway
New York, NY 10018
Telephone: Commercial (212) 642-6900

- t. TB 5-4200-200-10, HQDA, 1 September 1989, Subject: Hand Portable Fire Extinguisher Approved for Army Users.
- u. MIL-STD-129L, DOD, 15 October 1990, Military Standard Marking for Shipment and Storage.
- v. AR 200-1, HQDA, 23 April 1990, Environmental Protection and Enhancement.

APPENDIX A

REFERENCES

The publications listed below are referenced in this manual and contain information pertinent to lead-acid batteries:

DA PAM 738-750	The Army Maintenance Management System
TM 5-6115-271-14	Operator, Organizational, Direct Support and General Support Maintenance Instructions for Generator Set, Gasoline Engine, 3KW, DC, 8V, Model MEP-026A
TM 5-6115-271-24P	Operator, Organizational, Direct Support and General Support Maintenance Instructions with Repair Parts List and Special tools List for Generator Set, Gasoline Engine, 3KW, 8V, Model MEO-026A
TM 5-6130-301-13&P	Operator, Organizational and Direct Support Maintenance Instructions with Repair Parts List for Battery Charger Distribution Panel MR-R-52457, NSN 6130-00-940-7855
DA Pam 385-3	Protective Clothing and Equipment
TB 600-1	Procedures for selection, Training, Testing and Qualifying Operators of Equipment Systems, Excluding Selected Water craft and Aircraft Managed/Supported by U.S. Army Tank-automotive and Armaments Command.
TB 43-0134	Disposition and Disposal of rechargeable lead-acid batteries
TM 9-4910-571-12&P	STE/ICE

APPENDIX B

MAINTENANCE ALLOCATION CHART

Section I, INTRODUCTION

B-1. General.

This section provides a general explanation of all maintenance and repair functions authorized at various maintenance categories. This appendix is divided into three sections as follows:

- a. The Maintenance Allocation Chart (MAC) in Section II designates overall authority and responsibility for performance of maintenance functions on the identified end item or component. The application of the maintenance functions to the end item or component will consistent with the capacities and capabilities of the designated maintenance categories.
- b. Section III lists the tools and test equipment (both special and common tool sets) required for each maintenance function as referenced in section II.
- c. Section IV contains supplemental instructions and explanatory notes for particular maintenance function.

B-2. Maintenance Functions.

Maintenance Functions will be limited to and defined as follows:

- a. Inspect. To determine the serviceability of an item by comparing its physical, mechanical and /or electrical characteristics with established standards through examination (e.g. by sight, sound, or touch).
- b. Test. To verify serviceability by measuring the mechanical, pneumatic, hydraulic, or electrical characteristics of an item and comparing those characteristics with prescribe standards.
- c. Service. Operations required periodically to keep an item in proper operating condition, i.e., to clean (includes decontaminate, when required), preserve, drain, paint, or replenish Liquids, fuel, lubricants, or gasses.

TM 9-6140-200-14

- d. Adjust. To maintain or regulate, within prescribed limits by bringing into proper or exact position or by setting the operating characteristics to specified parameters.
 - e. Align. To adjust specified variable elements of an item to bring about optimum or desired performance.
 - f. Calibrate. To determine and cause corrections to be made or to be adjusted on instruments or test, measuring, and diagnostic equipment used in precision measurement. Consists of comparisons of two instruments, one of which is a certified standard of known accuracy, to detect and adjust any discrepancy in the accuracy of the instrument being compared.
 - g. Remove/install. To remove and install the same item when required to perform service or other maintenance functions. Install may be the act of emplacing, seating or fixing into position a spare, repair part, or module (component or assembly) in a manner to allow the proper functioning of a piece of equipment or system.
 - h. Replace. To remove an unserviceable item and install a serviceable counterpart in its place. Replacement is authorized by the MAC and shown as the 3rd position code of the SMR code.
 - i. Repair. The application of maintenance services^①, including fault troubleshooting ^②, removal/installation, and disassembly/assembly procedures^③, and maintenance actions^④, to identify trouble and restore serviceability to an item by correcting specific damage, fault, malfunction in a part, subassembly, module (component or assembly), end item or system.
-

- ① Service- inspect, test, service, adjust, aline, calibrate, and/or replace.
- ② Fault- locate/troubleshoot- the process of investigating and detecting the cause of equipment malfunction, the act of isolating a fault within a system or unit under test (UUT).
- ③ Disassemble/assemble- encompasses the step-by-step taking apart (or breakdown) of a spare/function group coded item to the level of its least componency identified as maintenance under consideration.

- ④ Actions- welding, grinding, riveting, straightening, facing, rematching and /or resurfacing.
- j. Overhaul. That maintenance effort (service or action) prescribed to restore an item to completely serviceable/operational condition as required by maintenance standards in appropriate technical publications (i.e., DMWR). Overhaul is normally the highest degree of maintenance performed by the Army. Overhaul does not normally return an item to like new condition.
- k. Rebuild. Consists of those services/actions necessary for the restoration of unserviceable equipment to a like new condition in accordance with original manufacturing standards. Rebuild is the highest degree of material maintenance applied to Army equipment. The rebuild operation includes the act of returning to zero those age measurements (hours/miles, etc.) considered in classifying Army equipment/components.

B-3. Explanation of Columns in the MAC, Section II.

- a. Column 1, Group Number. Column 1 lists functional group code numbers, the purpose of which is to identify maintenance significant components, assemblies, subassemblies, and modules with the next higher assembly. End item group number shall be "0".
- b. Column 2, Component/Assembly. Column 2 contains the names of components, assemblies, subassemblies, and modules for which maintenance is authorized.
- c. Column 3, Maintenance Function. Column 3 list the functions to be performed on the item listed in column 2. (See paragraph c-3 for detailed explanation of these functions.)

TM 9-6140-200-14

d. Column 4, Maintenance category. Column 4 specifies, by the listing of a work time figure in the appropriate subcolumn (s), the category of maintenance authorized to perform the function listed in column 3. This figure represents the active time required to perform that maintenance function at the indicated category of maintenance. If the number or complexity of the tasks within the listed maintenance function vary at different maintenance categories, appropriate work time figures will be shown for each category. The work time figure represents the average time required to restore an item (assembly, subassembly, components, module, end item, or system) to a serviceable condition under typical field operating conditions. This time includes preparation time (including any necessary disassembly/assembly time), troubleshooting/fault location, and quality assurance/quality control time in addition to the time required to perform the specific tasks identified for the maintenance functions authorized in the MAC. The symbol designations for various maintenance categories are listed below:

- C.....Operator/Crew
- O..... Unit Maintenance
- F..... Direct Support
- H.General Support
- D..... Depot

e. Column 5, Tolls and Equipment. Column 5 specifics, by code, those common tool sets (not individual tools) and special tools, TMDE, and support equipment required to perform the designated function.

f. Column 6, Remarks. This column shall, when applicable, contain a letter code in alphabetical order, that shall be keyed to the remarks contained in section IV.

B-4. Explanation of Columns in Tools and Test Equipment Requirements, Section III.

- a. Column 1, Reference code. The tools and test equipment reference code correlates with a code used in the MAC, Section II, column 5.
- b. Column 2, Maintenance category. The lowest category of maintenance authorized to use the tool or test equipment.
- c. Column 3, Nomenclature. Name or identification of the tool or test equipment.
- d. Column 4, National Stock Number. The national stock number of the tool or test equipment.
- e. Column 5, Tool Number. The manufacturer's part number.

B-5. Explanation of Columns in Remarks, Section IV.

- a. Column 1, Reference Code. The code recorded in column 6, Section II.
- b. Column 2, Remarks. This column lists information pertinent to the maintenance function being performed as indicated in the MAC, Section II.

Section II. MAINTENANCE ALLOCATION CHART

FOR

LEAD-ACID STORAGE BATTERIES

4HN, 24 VOLT (DRY)NSN 6140-00-059-3528	M11188/2-24v
4HN, 24 VOLT (WET)NSN 6140-01-396-1968	M11188.2-24v
2HN, 12 VOLT (DRY)NSN 6140-00-053-2553	MS35000-2
2HN, 12 VOLT (WET)NSN 6140-01-390-1969	MS35000-2
6TN, 12 VOLT (DRY)NSN 6140-00-057-2554	MS35000-3
6TL, 12 VOLT (DRY)NSN 6140-01-210-1964	MS52149-1
6TL, 12 VOLT (WET)NSN 6140-01-051-4900	MS52149-2
6TLFP, 12 VOLT (DRY)NSN 6140-01-431-1172	6TLFP
6TMF, 12 VOLT (DRY)NSN 6140-01-446-9498	6TMF
6TMF, 12 VOLT (WET)NSN 6140-01-446-9506	6TMF
6TGEL, 12 VOLT (GEL)NSN 6140-01-444-2545	6TGEL
NBB 248,12 VOLT (GEL)NSN 6140-12-190-9024	NBB248
NBB248, 12 VOLT (GEL)NSN 6140-01-439-0616	NBB248GTW

(1) Group Number	(2) Component Assembly	(3) Maintenance Function	(4) Maintenance Level					(5) Tools and Equipment	(6) Remarks
			C	O	F	H	D		
06	ELECTRICAL								
0612	BATTERY STORAGE	INSPECT		0.1	0.1				A
		TEST		0.2	0.2			3, 16, 17, 18, AND 19	A&B
		SERVICE		0.3	0.3			1,2,3,4,5,6, 7,13,15,17, 19, AND 20	A&B
		REPAIR			0.5			1,8,9,10,14, 15 AND 20	B
		REPLACE/ INSTALL		0.5				15 AND 21	A

TOOLS AND TEST EQUIPMENT REQUIREMENTS

(1) Reference Code	(2) Maintenance Level	(3) Nomenclature	(4) National Stock Number	(5) Tool Part Number
1	O	Brush, Wire	7920-00-291-5815	
2	O	Charger, Battery	6130-01-423-5737	PP-1660E/U
3	O	Cleaning Tool Terminal	5120-00-926-5175	AGH-3024
4	O	Distribution Panel	6130-00-940-7866	Model 4D- 100
5	O	Filler, battery, gravity	6140-00-752-2184	
6	O	Filter, battery, syringe	6140-00-808-7325	
7	O	General Mechanic Tool Kit	5120-00-177-7033	
8	O	Generator Set 3KW	6115-00-017-8239	MEP-026A
9	F	Ladle, melting	5120-00-222-1705	
10	F	Mold, negative (-) post	5120-00-251-5046	
11	F	Mold, positive (+) post	5120-00-251-5045	
12	O	Multi meter	6625-01-139-2512	
13	O	Pliers, Removal	5120-00-248-9407	
14	O	Pliers, Spreader Terminal	5120-00-943-9929	
15	F	Pot, melting 115v. 6qt.	5120-00-242-1273	
16	O	Puller, battery terminal	5120-00-944-4268	

TOOLS AND TEST EQUIPMENT REQUIREMENTS (CON'T)

(1) Reference Code	(2) Maintenance Level	(3) Nomenclature	(4) National Stock Number	(5) Tool Part Number
17	F	Respirator, air filtering	4240-00-099-6939	
18	O	Strap, battery carrying	5120-00-529-4124	
19	O	Tester, (hydrometer)	6630-00-171-5126	
20	O	Tester, load (hand held)	6630-01-447-7294	YA-201
21	O	Tester, optical battery & Anti-freeze	6630-00-105-1418	
22	F	Tester, Load (Hand Held)	6630-01-433-6786	Micro400
23	F	Tool Kit, battery service	5180-00-051-3806 LIN W33346	TK-170/G

Section IV. REMARKS

Reference Code	Remarks
A	Organizational Maintenance servicing of batteries consists of testing, recharging, checking electrolyte, adding distilled water and removing/installing batteries.
B	Direct Support and General Support maintenance of batteries includes all required maintenance functions i.e. charging, repairing, putting into service and testing.

APPENDIX C

EXPENDABLE/DURABLE SUPPLIES AND MATERIALS LIST

SECTION I. INTRODUCTION

C-1. Scope.

This appendix lists expendable supplies you will need to maintain the battery. These items are authorized to you by CTA 50-970, Expendable items (Except Medical, Class V, Repair Parts and Heraldic Items).

C-2. Explanation of Columns.

- a. Column 1- Item Number. This number is assigned to the entry in the listing.
- b. Column 2- Level. This column identifies the lowest level of maintenance that requires the listed item.

O..... Unit (Organizational)

F..... Direct Support

H..... General Support

- c. Column 3- National Stock Number. This number is the national stock number assigned to the item. Use it to request or requisition the item.
- d. Column 4- Item name, description, Commercial and Government Entity Code (CAGEC), and part number. This provides the other information you need to identify the item.
- e. Column 5- Unit of Measure (U/M). Indicates the measure used in performing the actual maintenance function, This measure is expressed by a two-character alphabetical abbreviation (e.g., ea., in., pr.). If the unit of measure differs from the unit of issue, requisition the lowest unit of issue that will satisfy your requirements.

Section II. EXPENDABLE/DURABLE SUPPLIES AND MATERIALS LIST

(1) Item Number	(2) Level	(3) National Stock Number	(4) Item Name. Description. CEGE and Part Number	(5) U/M
1	O	8010-01-034-0401	Adhesive, (16059) S205	Ea.
2	O	8415-00-082-6108	Apron, rubber, (58536) A-A-55063	Ea.
3	O	8010-00-959-4661	Coating, Epoxy, (80244) MIL-C-22750Typc2	Ea.
4	O	8030-00-290-5141	Compound, Bituminous (86273) MIL-C450Typell	Gl
5	O	2920-00-738-6272	Cover, Terminal Lug (19207) 10942521	Ea.
6	O	6810-00-682-6867 6810-00-356-4936	Distilled Water (19203) 829382 1 gallon container (80063) 6Z9250 5 gallon can	Gl
7	F	6810-00-249-9354 6810-00-843-1640 6810-00-893-8138	Electrolyte (19207) 10875529 1 gallon container (81348) 0-S-801 5 gallon can (81348) 0-S-801 15 gallon drum	Ea.
8	O	1845-00-641-4601	Gloves, Rubber (81348) zz-G-381	Pr.
9	O	4240-00-269-7912	Goggles, Industrial (73804) SO23A	Ea.
10	O	9150-00-935-1017 9150-00-190-0904 9150-00-190-0905	Grease, Automotive and Artillery (98308) BRAYCOTE610 14 ounces carton (98308) BRAYCOTE610 1 pound can (98308) BRAYCOTE610 5 pound can	Ea.
11	O	7690-00-477-3715	Label, battery cable lead, negative (-) (19207) 11630582-2	Ea.
12	O	7690-00-477-3714	Label, battery cable lead, positive (+) (19207) 11630582-1	Ea.
13	F	5050-00-965-0264	Lead, pig 5 pound bar (81348) QQ-C-40	Ea.

EXPENDABLE/DURABLE SUPPLIES AND MATERIALS LIST (CON'T)

(1) Item Number	(2) Level	(3) National Stock Number	(4) Item Name, Description, CEGE and Part Number	(5) U/M
14	O	6810-00-264-6618 6810-00-290-5574	Soda, Baking (81348) O-S-576 1 pound Soda, Baking (81348) O-S-576 100 pound	Ea Ea
15	O	8040-01-331-7134 8040-01-331-7133	Silicone, Compound (33530) 982 1-pint Silicone, 3 oz. (33530) 982	Ea Ea
16	O	5970-01-101-4147	Washer, Felt (54095) NOCO-117	Ea
17	O	9320-00-060-9363 6160-01-389-1966	Pad 2x2 ¼" thick (81349) MIL-R-3065 Mat, Battery Roll (OYA21) 74-216549-2404	Ea Ea
18	O	6130-01-449-7590 6130-01-449-7594	Solar, Charging System (12 volt) (09GZ5) VC-4 Solar, Charging System (24 volt) (09GZ5) VC-5	Ea Ea
19	O	6140-01-387-5045	Cap, Battery (81349) MS52149-4	Ea.
20	O	N/A	Protector, Battery P/N 80370	Ea.

APPENDIX D

GUIDANCE FOR LOCAL BATTERY SHOP SOP

The following procedure contains pertinent details for safe operations in charging and servicing batteries. Each battery shop shall operate in accordance with the local internal and external SOP, as developed and enforced by the command office concerned.

NAME OF OFFICE

STANDARD OPERATING PROCEDURE

NO. _____

Date: _____

1. Purpose.

To establish safe operating procedures and assign responsibilities to cover battery cleaning, servicing and charging.

2. Applicability.

This procedure applies to the charging and servicing of lead-acid storage batteries associated with work operations in Building _____.

3. Responsibility.

The immediate supervisor is responsible for:

- a. Application and enforcement of this procedure.
- b. Insuring that only qualified personnel are permitted to engage in the operations.
- c. Insuring that the building leader is thoroughly briefed and is responsible for insuring that only qualified personnel are permitted to engage in the operation.

4. Location of Operation.

Building _____

5. Personnel Limits.

The number of personnel permitted to engage in charging operations will be restricted to the minimum required to perform the job in a safe and efficient manner.

6. Material Limits.

The number of batteries and amount of electrolyte will be limited to the number and quantity needed to perform a safe and efficient operation.

7. Safety Requirements (Coordinate with Federal, State and local agencies).

Industrial requirements include those below:

- a. The charging rate will at all times be kept low enough to prevent boiling over of the contents of a battery cell, and the rapid generation of hydrogen gas. The battery manufacturer as recommended charging rate should be used.
- b. The immediate charging area will be thoroughly ventilated for riddance of acid fumes. If acid fumes are prevalent despite this ventilation precaution all operation will be suspended until the air has been cleared. Personnel will not remain in the area.
- c. Addition of electrolyte to batteries is not permitted except in the Battery Room, Building _____. Repairs to batteries will be done in building _____.
- d. Smoking or the use of an open flame, spark-producing devices, or other ignition sources is restricted to approved and posted rooms and areas.
- e. Care will be taken to ensure prevention of short circuits while batteries are being handled or charged. Tools and loose metal objects will not be placed in such a position that they may fall on the batteries. Wrenches and other tools must be carefully used to avoid short circuits. A short circuit may not only cause serious burns, but may also result in an explosion of accumulated hydrogen. All lights and electrical sockets will be spark proof.
- f. Charging units will be periodically checked during operation.
 - f. When applicable, surfaces supporting the batteries will be covered with baking soda to neutralize any acid spillage.

- h. Rags contaminated by cleaning operations will be placed in covered metal container and later disposed of by burning.
- i. Safety steel-toed shoes will be worn during operations.
- j. Chemical goggles, face shields, rubber gloves, and a rubber apron will be worn during battery handling and servicing.

8. Leading Operations.

Use of pig lead in making new battery posts will be made in Building_____.

- a. The leading area will be thoroughly ventilated to get rid of lead fumes and lead dust. If lead fumes are prevalent despite this ventilation requirement, the leading operation will be suspended until air has been cleared. Personnel will not remain in the area.
- b. The melting and pouring of lead into battery post molds will be done on a work bench under an exhaust hood. Lead fumes must not be breathed.
- c. Safety goggles, face shields, rubber gloves and an apron will be worn when pouring molten lead into dry molds. To prevent spattering of hot lead, do not pour molten lead into a wet or damp mold.
- d. Clothes worn during leading operations will not be worn outside the Battery Shop. These clothes are not to be worn home or for other purposes.
- e. Care will be taken to prevent dust size particles of lead from melting, spattering, or being ingested (taken internally).
- f. Eating and smoking are prohibited in the leading area and battery shop.
- g. Safety controls on personnel include the following:
 - (1) A pre-placement physical examination, including analysis for lead concentration in urine and blood. Periodic follow-up physical examinations (recommended every six months).
 - (2) Through training on all aspects of the job, including precautions and personal hygiene.

TM 9-6140-200-14

- (3) Personal protection equipment requirements are: approved metal fume respirator, safety face shield, and work clothes that are worn only on this job and changed before leaving the leading area.
- (4) Work stations are to be surveyed by an industrial specialist for the lead concentrations in the operator breathing zone, and all other aspects of the operation for good industrial hygiene practices.
- (5) The Threshold Limit Value (TLV) for lead is 0.5 mg per cubic meter.

9. Personal Protection Clothing Equipment (OSHA Approval Equipment).

These items include the following:

- a. Industrial safety shoes,
- b. Chemical goggles.
- c. Rubber gloves or chemical hazard gloves.
- d. Rubber apron or approved coveralls.
- e. Face shield.
- f. Full-Face Respirator, air filtering

10. First aid and fire Equipment.

- a. Fire Extinguisher.
- b. Spray type eye wash fountain.
- c. Deluge shower.
- d. First Aid Kit.

11. Operating Equipment.

Reference Appendix D for this equipment.

12. Procedure.

Battery charging, servicing, and repair will be done in accordance with TM 9-6140-200-14 and (list other documents pertinent to your operation and location).

13. Ventilation (Approved by OSHA Standards).

Open doors to secure ventilation or turn on ventilation fan. After the charging area has been properly ventilated, turn on the charging unit.

14. Posting.

After this sample SOP has been developed and approved by concerned command offices, a copy will be prominently displayed at the operating site.

SUBMITTED BY: _____

RECOMMENDING APPROVAL: _____

APPROVED: _____

TYPICAL BATTERY SHOP LAYOUT

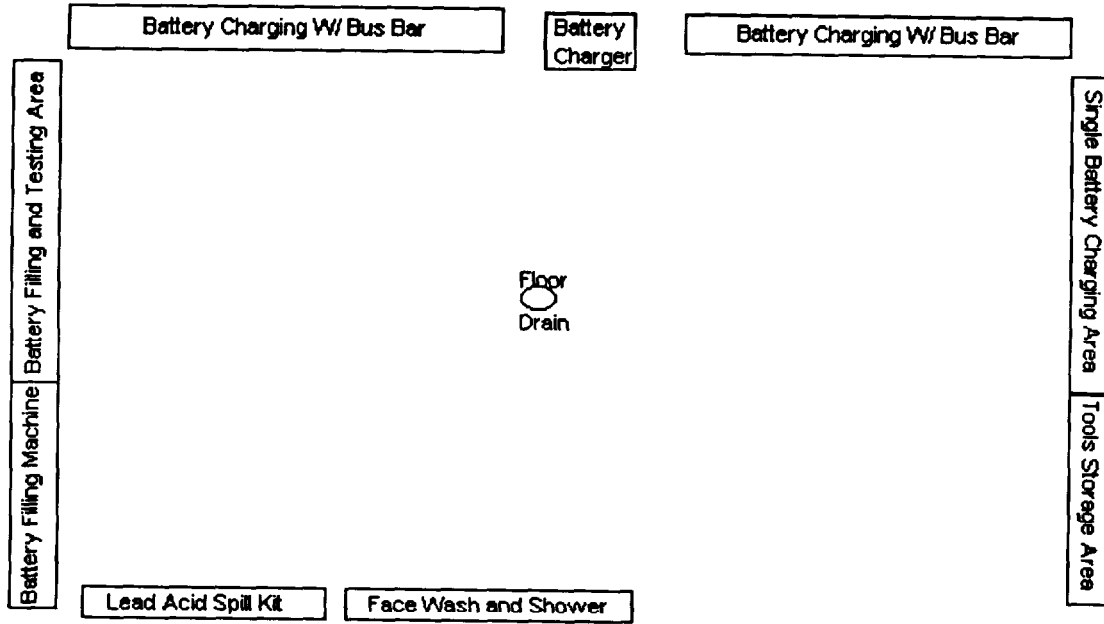

APPENDIX E

Procedures For Draining Lead-Acid Batteries and Disposition of Drained Sulfuric Acid (Electrolyte)

E-1. Purpose

The establish procedures for the draining of Lead-Acid (LA) batteries and the disposition of drained sulfuric acid (H₂SO₄) electrolyte, through the local servicing Defense Reutilization and Marketing Office (DRMO). DO NOT drain batteries unless:

- a. Batteries are damaged, or
- b. Batteries cannot be protected from freezing.

E-2. Application

This procedure applies to Army procured Lead-Acid batteries, described in this Technical Manual (TM).

E-3 Safety and Control Measures

- a. Refer to Appendix C for required Personal Protective Equipment (PPE).
- b. Battery electrolyte should be stored in a cool, dry, well ventilated. If the local servicing DRMO cannot provide adequate storage, the user MUST provide protected storage to prevent the electrolyte from freezing.

E-4 Procedure

Packaging and shipping instructions contained herein are consistent with US Department of Transportation (DOT) and US Environment Protection Agency (EPA) regulations, and Department of Defense (DOD) guidance.

- a. Transfer of electrolyte to local servicing DRMO is controlled by DOD guidance. Coordinate packaging and shipping with your local Installation Environmental Office (IEO), Installation Transportation Office (ITO), and local servicing DRMO.

WARNING

DO NOT use metal or galvanized equipment when draining electrolyte from Lead Acid batteries

CAUTION

Personnel **MUST** wear PPE while draining vented batteries. Refer to Appendix C.

b. Draining:

- (1) Drain batteries into a plastic bucket, and transfer the spent electrolyte into a DOT specification 34 plastic drum, or any other DOT approved drum for H₂SO₄.
- (2) The exterior of all drained batteries should be rinsed with water and baking soda to remove acid residue. Use care and avoid splashing. Allow exteriors to dry. The exterior of all batteries must be completely dry prior to packaging.
- (3) The vent/filler caps should be replaced and taped in place after draining and the vent holes sealed with the same tape.

ITEM	NSN	SOS
Pail, 12 quart, plastic	7240-00-943-7105	GO
Funnel, gallon, plastic	7240-00-404-9795	GO
Drum	8110-01-150-0677	S9G
Tape, Electrical, 3/4 inch	5970-00444-3167	GO

E-5. Transportation Requirements

- a. For LA battery casings, for packaging of drained battery casings for disposition see your local servicing DRMO SOP.

b. For spent electrolyte, in accordance with Title 49, CFR Part 172.101 HMT, Hazard Class 8, and Part 173.154:

(1) Packaging: in accordance with 49 CFR Part 173.154;

(2) Marking: Proper shipping name; Battery fluid; UNID: UN 2796; label IAW 49 CFR Part 172.442: CORROSIVE label.

E-6 Disposition and Transportation

- a. Coordinate and obtain guidance regarding this turn-in from the local servicing DRMO and ITO. Battery electrolyte may be turned in to the DRMO for disposition, or may be disposed via local contractor. A disposal Turn-in Document (DA Form 1348-1) and a Hazardous Waste Profile Sheet (DRMS Form 1930) or Material Safety Data Sheet are required by the servicing DRMO.
- b. The DRMO will accept accountability, provided the materials are properly identified, packaged and marked, and will accept physical custody depending upon the availability of conforming storage areas.

APPENDIX F

Disposal Requirements by State

NOTE

The following information is based on a survey completed 30 September 1991.

Alabama	Solid Waste Section State regulations ban disposal of Lead-Acid (LA) batteries.	(205) 271-7770
Alaska	Hazardous and Solid Waste Section State Hazardous Waste (HW) characterizations requirements include bioassay.	(907) 465-2671
Arkansas	Division of Solid Waste State regulates recycling; ban disposal of LA batteries	(501) 570-2858
Arizona	Solid Waste Unit State regulates recycling; bans disposal of LA batteries.	(602) 257-2155
California	Alternative Technology Division State HW characterization requirements include bioassay. Sate bans disposal of LA batteries	(916) 324-1807
Colorado	Waste Management State regulates recycling of LA batteries.	(303) 331-4400
Connecticut	Bureau of Waste Management State regulates recycling and bans disposal of LA batteries.	(203) 566-5217
Delaware	Waste Management Section None.	(302) 739-3689
Washington, DC	Pesticide and Hazardous Waste Branch None.	(202) 404-1167
Florida	Solid Waste Section State regulates recycling of LA batteries.	(904) 922-6104

TM 9-6140-200-14

Georgia	Hazardous Waste Technical Assistance Program State regulates recycling of LA batteries.	(404) 894-3806
Hawaii	Solid and Hazardous Waste Branch State regulates recycling and bans disposal of LA batteries.	(808) 543-8226
Iowa	Waste Management Authority None.	(515) 281-5145
Idaho	Hazardous Materials Bureau None.	(208) 334-5879
Illinois	Environmental Protection Agency State regulates recycling and bans disposal of LA batteries.	(217) 782-6762
Indiana	Compliance Section State regulations ban disposal of LA batteries.	(317) 232-4417
Kansas	Solid Waste Section None.	(913) 296-1590
Kentucky	Solid Waste Section State regulates recycling and bans disposal of LA batteries.	(502) 564-6716
Louisiana	Hazardous Waste Enforcement Section State regulations ban disposal of LA batteries.	(504) 765-0355
Maine	Solid Waste Division State regulates recycling and bans disposal LA batteries.	(207) 582-8740
Maryland	Hazardous Waste Program None	(301) 631-3343
Massachusetts	Solid Waste Management Division State regulations bans disposal of LA batteries.	(617) 292-5980
Michigan	Waste Management Division State regulates recycling and bans disposal of LA batteries.	(517) 373-2730

TM 9-6140-200-14

Minnesota	Pollution Control Agency State HW characterization requirements include bioassay. State regulates recycling and bans disposal of LA batteries	(612) 643-3470
Mississippi	Office of Pollution Control None.	(601) 961-5171
Missouri	Waste Management Program State regulates recycling and bans disposal of LA batteries.	(314) 751-3176
Montana	Solid and Hazardous Waste Bureau None	(406) 444-1430
Nebraska	Waste Recovery Section None.	(402) 471-4210
Nevada	Bureau of Waste Management None.	(702) 687-5872
New Hampshire	Waste Management Division State regulations ban disposal of LA batteries.	(603) 271-2942
New Jersey	Office of Recycling None.	(609) 530-8593
New Mexico	Hazardous and Radiological Waste Bureau None.	(505) 827-2929
New York	Determination and Compliance Section None.	(518) 457-6858
North Carolina	Hazardous Waste Section State regulates recycling and bans disposal of LA batteries.	(919) 733-2178
North Dakota	Division of Waste Management State regulations ban disposal of LA batteries.	(701) 221-5166
Ohio	Division of Solid and Hazardous Waste Management None.	(614) 644-2956

TM 9-6140-200-14

Oklahoma	Hazardous Waste Management Service None	(405) 271-5338
Oregon	Hazardous Waste Reduction and Technical Assistance State regulates recycling and bans disposal of LA batteries.	(503) 229-5913
Pennsylvania	Waste Determination Section State regulates recycling and bans disposal of LA batteries.	(717) 787-7381
Puerto Rico	Land Pollution Control Department	(809) 767-8118
Rhode Island	Division of Air and Hazardous Material State HW characterization requirements include bioassay.	(401) 277-2797
South Carolina	Waste Assessment Section State regulates batteries as a special waste (SPW), and batteries must be disposed of in accordance with SPW regulations.	(803) 734-5000
South Dakota	Division of Environmental Regulation State regulates LA batteries as SPW, and LA batteries must be disposed of in accordance with SPWO regulations.	(605) 773-3153
Tennessee	Division of Solid Waste Management State regulations ban disposal of LA batteries.	(615) 741-3424
Texas	Bureau of Solid and Hazardous Waste State regulates recycling and bans disposal of LA batteries.	(512) 458-7271
Utah	Bureau of Solid and Hazardous Waste	(801) 538-6170
Vermont	Division of Hazardous Material State regulations ban disposal of batteries classified as HW.	(802) 244-8702
Virginia	Department of Waste Management	(804) 225-2667
Washington	Hazardous Waste Section State HW characterization requirements include bioassay. State regulates recycling of LA batteries.	(206) 459-8322

TM 9-6140-200-14

West Virginia Pollution Prevention (304) 348-4000
State regulations ban disposal of LA batteries.

Wisconsin Bureau of Solid and Hazardous Waste Management (608) 266-2111
State regulates recycling of LA batteries. Recyclable material
managed as HW.

Wyoming Solid Waste Program (307) 777-7752
State regulates recycling and bans disposal of LA Batteries.

APPENDIX G

GLOSSARY

G-1. Purpose.

To explain and define items as used in the context of this TM.

G-2. Definitions.

- a. **Balanced Cell.** A battery cell so designed that during discharges, its reactive constituents (anode and cathode) are depleted in a quantitatively even manner.
- b. **Battery.** A portable power supply unit made up of one or more cells with all necessary connections, fusing, wiring, and container to provide power to an article application.
- c. **Bioassay.** Chemically independent test used by some states to characterize solid waste as hazardous waste.
- d. **Cell.** The smallest power producing unit of a battery.
- e. **Conforming Storage.** Storage which meets acceptable standards for the material being stored. Your local servicing Defense Re-utilization and Marketing Office (DRMO) may take accountability but not physical custody unless they can provide adequate safe storage.
- f. **Consignee.** The person or activity shipping the material (batteries) to the local DRMO, for disposition and disposal, e.g., the local DRMO.
- g. **Consignor.** The person or activity shipping the material (batteries) to the local DRMO, for disposition and disposal.
- h. **Damaged.** A cell or battery which is broken, bulged, cracked, split, etc., to the degree that one or more cells or the case have lost physical integrity and cell contents may leak, or have leaked out.

TM 9-6140-200-14

- i. Defective. Any battery other than depleted, which will not operate its assigned equipment, provided the equipment is not responsible for this lack of operation.
- j. Depleted. Any battery which has been used to the end of its duty cycle (i.e., to its cut-off or end of life voltage).
- k. Disposal. Burying, crushing, destroying, burning, incinerating, or discarding into the general refuse/trash.
- l. Disposition. The transfer of unserviceable battery (ies) or electrolyte to the local servicing DRMO Activity for disposal. The DRMO activity has the option to recycle this transferred material.
- m. Dry Cell. A cell in which the electrolyte is not free flowing.
- n. Duty Cycle Discharge. A battery discharged to the point where it will no longer operate its intended equipment.
- o. Electrolyte. The electrically conductive fluid or gelled contents of a cell.
- p. EPA Hazardous Waste Number. A number assigned to a particular hazardous waste under Resource Conservation and Recovery Act regulations.
- q. Hazardous Material. A substance or material containing a substance, which has been determined by the Secretary of Transportation to be capable of health, safety, and/or hazardous property when transported in commerce, and which has been so designated.
- r. Hazardous Material Table (HMT). Table (title 49, Code of Federal Regulations, Part 172.101) which lists materials which are considered hazardous during transportation. Materials listed in this HMT are regulated under US Department of Transportation regulations. OCONUS = host country and/or status of Forces Agreement.
- S. Hazardous Waste. A waste that is listed or exhibits any of the characteristics as defined in accordance with existing federal (i.e. Title 40 CFR, Part 261, subpart C or D), state or local regulations.
- t. Non-hazardous Solid Waste. A solid waste which is not a hazardous waste.

TM 9-6140-200-14

- u. Primary battery. A non-rechargeable battery.
- v. Recycled Material. Material that is reutilized, instead of being disposed as waste. IAW federal and state regulations material may be recycled, thereby removing potentially hazardous material from the waste stream so that it may be reused. The process is regulated under Title 40 CFR Parts 264, 265, 266, 268, and 270.
- w. Resource Conservation and Recovery Act. Federal law, enacted under Title 40, Code of Federal Regulations, which protects the environment by regulating the disposal and recycling of potentially hazardous wastes.
- x. Sealed battery. A battery without vent/filler caps.
- y. Secondary battery. A rechargeable battery.
- z. Serviceable Battery. A battery which can be used for its original intended purpose.
 - aa. Solid Waste. A material which is normally considered as trash, refuse or garbage, which is not a waste defined as a hazardous waste; r, above. It may be solid or liquid.
 - ab. Spent. See depleted.
 - ac. Unserviceable battery. A battery which is damaged, defective, depleted, spent, or has exceeded its shelf life.
 - ad. Vented battery. A battery with vented/filler cap (s). Typically contains wet cells which may be serviced by adding electrolyte or distilled water.
 - ae. Waste. Material determined to no longer have economic value or useful purpose.
 - af. Wet Cell. A cell with a fluid electrolyte.

By Order of the Secretary of the Army:

DENNIS J. REIMER
General, United States Army
Chief of Staff

Official:

JOEL B. HUDSON

Administrative Assistant to the
Secretary of the Army
05249

DISTRIBUTION: To be distributed in accordance with the initial distribution number (IDN) 340198 requirements for TM 9-6140-200-14.

RECOMMENDED CHANGES TO EQUIPMENT TECHNICAL PUBLICATIONS



THEN - JOT DOWN THE DOPE ABOUT IT ON THIS FORM. CAREFULLY TEAR IT OUT, FOLD IT AND DROP IT IN THE MAIL!

SOMETHING WRONG WITH THIS PUBLICATION?

FROM: (PRINT YOUR UNIT'S COMPLETE ADDRESS)

DATE SENT

PUBLICATION NUMBER
TM 9-8140-200-14

PUBLICATION DATE

PUBLICATION TITLE
Lead-Acid Storage Batteries

BE EXACT. PIN-POINT WHERE IT IS				IN THIS SPACE TELL WHAT IS WRONG AND WHAT SHOULD BE DONE ABOUT IT:
PAGE NO	PARA-GRAPH	FIGURE NO	TABLE NO	

PRINTED NAME, GRADE OR TITLE AND TELEPHONE NUMBER

SIGN HERE

FILL IN YOUR
UNITS ADDRESS



DEPARTMENT OF THE ARMY

OFFICIAL BUSINESS



NO POSTAGE
NECESSARY
IF MAILED
IN THE
UNITED STATES

BUSINESS REPLY MAIL

FIRST CLASS

PERMIT NO. 82

ROCK ISLAND IL

POSTAGE WILL BE PAID BY ROCK ISLAND ARSENAL

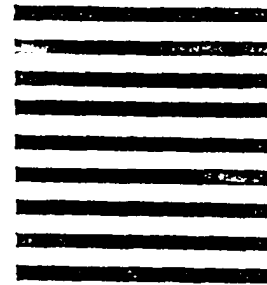

Director
Armament and Chemical Acquisition
and Logistics Activity
ATTN: AMSTA-AC-NML
Rock Island, IL 61201-9948

TEAR ALONG PERFORATED LINE



THE METRIC SYSTEM AND EQUIVALENTS

WEIGHT MEASURE

1 Centimeter = 10 Millimeters = 0.01 Meters = 0.3937 Inches
 1 Meter = 100 Centimeters = 1000 Millimeters = 39.37 Inches
 1 Kilometer = 1000 Meters = 0.621 Miles

WEIGHTS

1 Gram = 0.001 Kilograms = 1000 Milligrams = 0.035 Ounces
 1 Kilogram = 1000 Grams = 2.2 lb.
 1 Metric Ton = 1000 Kilograms = 1 Megagram = 1.1 Short Tons

LIQUID MEASURE

1 Milliliter = 0.001 Liters = 0.0338 Fluid Ounces
 1 Liter = 1000 Milliliters = 33.82 Fluid Ounces

SQUARE MEASURE

1 Sq. Centimeter = 100 Sq. Millimeters = 0.155 Sq. Inches
 1 Sq. Meter = 10,000 Sq. Centimeters = 10.76 Sq. Feet
 1 Sq. Kilometer = 1,000,000 Sq. Meters = 0.386 Sq. Miles

CUBIC MEASURE

1 Cu. Centimeter = 1000 Cu. Millimeters = 0.06 Cu. Inches
 1 Cu. Meter = 1,000,000 Cu. Centimeters = 35.31 Cu. Feet

TEMPERATURE

$5/9(^{\circ}\text{F} - 32) = ^{\circ}\text{C}$
 212° Fahrenheit is equivalent to 100° Celsius
 90° Fahrenheit is equivalent to 32.2° Celsius
 32° Fahrenheit is equivalent to 0° Celsius
 $9/5^{\circ}\text{C} + 32 = ^{\circ}\text{F}$

APPROXIMATE CONVERSION FACTORS

TO CHANGE	TO	MULTIPLY BY
Inches	Centimeters	2.540
Feet	Meters	0.305
Yards	Meters	0.914
Miles	Kilometers	1.609
Square Inches	Square Centimeters	6.451
Square Feet	Square Meters	0.093
Square Yards	Square Meters	0.836
Square Miles	Square Kilometers	2.590
Acres	Square Hectometers	0.405
Cubic Feet	Cubic Meters	0.028
Cubic Yards	Cubic Meters	0.765
Fluid Ounces	Milliliters	29.573
its	Liters	0.473
arts	Liters	0.946
allons	Liters	3.785
Ounces	Grams	28.349
Pounds	Kilograms	0.454
Short Tons	Metric Tons	0.907
Pound-Feet	Newton-Meters	1.356
Pounds per Square Inch	Kilopascals	6.895
Miles per Gallon	Kilometers per Liter	0.425
Miles per Hour	Kilometers per Hour	1.609

TO CHANGE	TO	MULTIPLY BY
Centimeters	Inches	0.394
Meters	Feet	3.280
Meters	Yards	1.094
Kilometers	Miles	0.621
Square Centimeters	Square Inches	0.155
Square Meters	Square Feet	10.764
Square Meters	Square Yards	1.196
Square Kilometers	Square Miles	0.386
Square Hectometers	Acres	2.471
Cubic Meters	Cubic Feet	35.315
Cubic Meters	Cubic Yards	1.308
Milliliters	Fluid Ounces	0.034
Liters	Pints	2.113
Liters	Quarts	1.057
ers	Gallons	0.264
ms	Ounces	0.035
ograms	Pounds	2.205
Metric Tons	Short Tons	1.102
Newton-Meters	Pounds-Feet	0.738
Kilopascals	Pounds per Square Inch	0.145
ometers per Liter	Miles per Gallon	2.354
ometers per Hour	Miles per Hour	0.621



PIN: 034044-000